

LED Backlight Driver and Multiple LDO Lighting Management Unit**General Description**

The AAT2870 is a highly integrated charge pump-based lighting management unit (LMU) providing eight independently configurable LED channels that can also be grouped into main or sub backlight controls. The built-in support for low cost ambient light sensors automates all brightness adjustments. In addition, four programmable low dropout (LDO) linear regulators are provided to supply other lighting and camera module functions. The LMU is optimized for single-cell lithium-ion/polymer systems making it ideal for portable devices.

A tri-mode negative charge pump provides power to backlight LEDs with improved efficiency over conventional charge pump topologies. All eight backlight LED current sinks are programmable up to 27.9mA. LEDs may be set individually or in groups for various arrays of backlight or keypad lighting applications. High frequency PWM dimming for both Main and Sub display backlighting is provided and is compliant to Content Adaptive Brightness Control (CABC) specifications with a PWM frequency up to 100 kHz.

The ambient light control features automatic sensor calibration and 50Hz/60Hz noise rejection for accurate brightness adjustment without processor intervention.

All AAT2870 functions are programmed using an industry standard bi-directional I²C interface. This interface can enable, disable, and set the backlight current to one of 32 levels (5 bits) for the backlight. Backlight current matching is better than $\pm 3\%$ for uniform display/sub-display brightness.

The AAT2870 also contains four high-performance low-noise, low dropout (LDO) linear regulators. Each regulator starts up with a default 1.2V and is adjustable by programming through the I²C interface. LDOA can supply up to 300mA, while LDOB, C and D can source up to 150mA to a system load.

The AAT2870 is available in a Pb-free, space-saving 3.1mm x 2.6mm, 30 ball CSP package rated over the -40°C to +85°C temperature range.

Features

- Charge Pump Input Voltage Range: 2.7V to 5.5V
- Tri-Mode Negative Charge Pump
 - Improved Efficiency
 - Drives up to Eight LEDs
 - 1.3MHz Switching Frequency
- Automatic Soft Start
- Industry Standard I²C Programming Interface
- Programmable Backlight Current (8 Channels)
 - 27.9mA Maximum Current per Channel
 - 32 Levels (5 bits): 0.45mA – 27.9mA
 - Independent Main or Sub Settings
 - Programmable Fade-On / Off
- Advanced Dimming Features:
 - Ambient Light Sensor Management
 - Direct Ambient Dimming Function
 - 128 Programmable Levels
 - PWM Dimming (CABC Compatible)
- Four Linear Regulators
 - LDOA up to 300mA
 - LDOB, C and D up to 150mA
 - 150mV Dropout
 - I²C Programmable Outputs: 1.2V to 3.3V
 - Output Auto-Discharge for Fast Shutdown
- Built-In Over-Temperature Protection
- -40°C to +85°C Temperature Range
- 3.1mm x 2.6mm, 0.5mm ball pitch, 30 ball CSP package

Applications

- Camera Enabled Mobile Devices
- Digital Still Cameras
- Smart Phones

AAT2870

LED Backlight Driver and Multiple LDO Lighting Management Unit

Typical Application

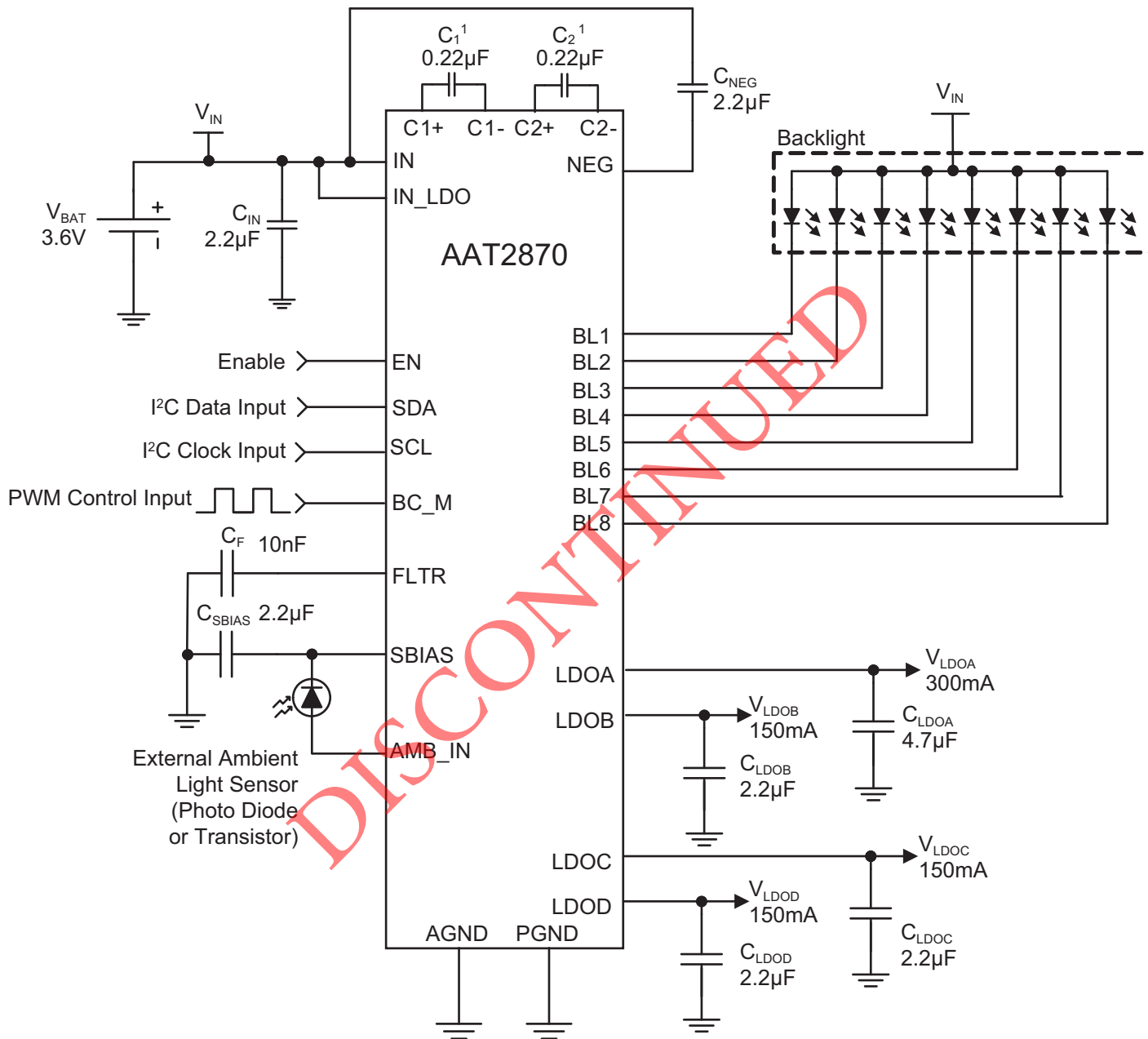

1. Or alternate value of 1µF.

LED Backlight Driver and Multiple LDO Lighting Management Unit

Pin Descriptions

Ball #	Symbol	Description
A1	LDOA	LDOA regulated voltage output pin. Bypass LDOA to AGND with a 4.7 μ F or larger ceramic capacitor as close to the AAT2870 as possible.
A2	LDOD	LDOD regulated voltage output pin. Bypass LDOD to AGND with a 2.2 μ F or larger ceramic capacitor as close to the AAT2870 as possible.
A3	AGND	Analog ground. Connect AGND to PGND at a single point as close to the AAT2870 as possible.
A4	IN_LDO	Input power supply pin for all four LDO voltage regulators. Must be externally connected to IN.
A5	IN	Power input that is internally connected to IN_LDO. Connect IN to the input source voltage and bypass to PGND with a 2.2 μ F or larger ceramic capacitor as close to the AAT2870 as possible. Connect LED anodes to IN.
B1	LDOB	LDOB regulated voltage output pin. Bypass LDOB to AGND with a 2.2 μ F or larger ceramic capacitor as close to the AAT2870 as possible.
B2	LDOC	LDOC regulated voltage output pin. Bypass LDOC to AGND with a 2.2 μ F or larger ceramic capacitor as close to the AAT2870 as possible.
B3	SBIAS	Ambient light sensor bias supply output. This pin provides a regulated bias supply to the attached ambient light sensor. Refer to "Ambient Light Sensor Voltage Bias" in the Application Information section of this datasheet for more details.
B4	C1+	Positive terminal of charge pump capacitor 1. Connect the 0.22 μ F ¹ charge pump capacitor 1 from C1+ to C1-.
B5	C2+	Positive terminal of charge pump capacitor 2. Connect the 0.22 μ F ¹ charge pump capacitor 2 from C2+ to C2-.
C1	AMB_IN	Ambient light sensor input connection pin. Connect the photo diode anode or ambient light sensor module output to this pin.
C2	FLTR	BC_M PWM input filter capacitor pin. Connect a 10nF ceramic capacitor between this pin and AGND.
C3	SDA	I ² C serial data pin. This pin is bi-directional.
C4	C2-	Negative terminal of charge pump capacitor 2.
C5	PGND	Power ground. Connect AGND to PGND at a single point as close to the AAT2870 as possible.
D1	BC_M	Content adjustable brightness control PWM signal input. Refer to "Content Adjustable Brightness Control" in the Application Information section of this datasheet for more details.
D2	EN	Enable pin. Drive high to enable, low to shutdown.
D3	SCL	I ² C serial clock input pin
D4	C1-	Negative terminal of charge pump capacitor 1.
D5	NEG	Charge pump output. NEG is the output of the charge pump and supplies current to the backlight LEDs. Bypass NEG to IN with a 2.2 μ F or larger ceramic capacitor located as close to the AAT2870 as possible.
E1	AGND	Analog ground. Connect AGND to PGND at a single point as close to the AAT2870 as possible.
E2	BL7	Backlight LED 7 current sink. BL7 controls the current through backlight LED 7. Connect the cathode of backlight LED 7 to BL7. If not used, connect BL7 to IN.
E3	BL5	Backlight LED 5 current sink. BL5 controls the current through backlight LED 5. Connect the cathode of backlight LED 5 to BL5. If not used, connect BL5 to IN.
E4	BL4	Backlight LED 4 current sink. BL4 controls the current through backlight LED 4. Connect the cathode of backlight LED 4 to BL4. If not used, connect BL4 to IN.
E5	BL2	Backlight LED 2 current sink. BL2 controls the current through backlight LED 2. Connect the cathode of backlight LED 2 to BL2. If not used, connect BL2 to IN.
F1	BL8	Backlight LED 8 current sink. BL8 controls the current through backlight LED 8. Connect the cathode of backlight LED 8 to BL8. If not used, connect BL8 to IN.
F2	BL6	Backlight LED 6 current sink. BL6 controls the current through backlight LED 6. Connect the cathode of backlight LED 6 to BL6. If not used, connect BL6 to IN.
F3	PGND	Power ground. Connect AGND to PGND at a single point as close to the AAT2870 as possible.
F4	BL3	Backlight LED 3 current sink. BL3 controls the current through backlight LED 3. Connect the cathode of backlight LED 3 to BL3. If not used, connect BL3 to IN.
F5	BL1	Backlight LED 1 current sink. BL1 controls the current through backlight LED 1. Connect the cathode of backlight LED 1 to BL1. If not used, connect BL1 to IN.

1. Or alternate value of 1 μ F.

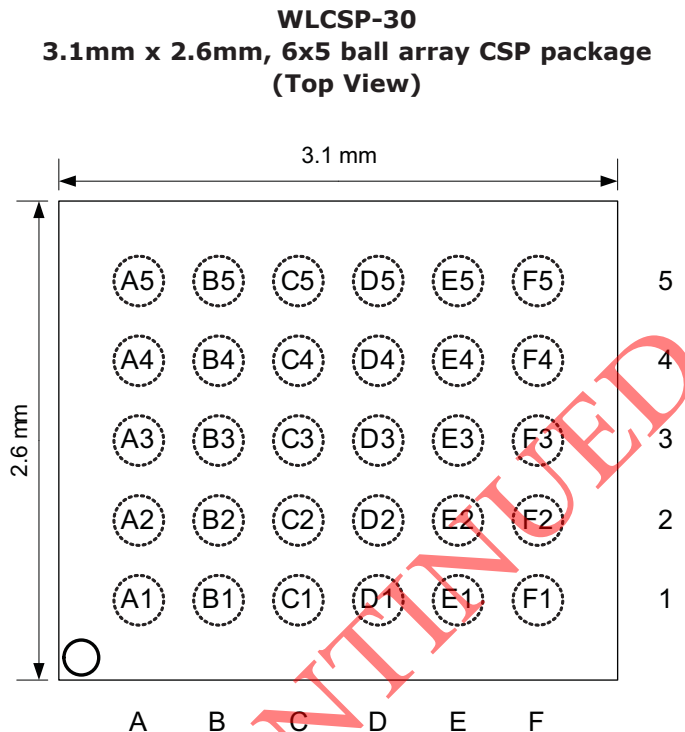
LED Backlight Driver and Multiple LDO Lighting Management Unit**Pin Configuration****Absolute Maximum Ratings¹**

Symbol	Description	Value	Units
	IN to AGND, PGND	-0.3 to 6.0	V
	BL1, BL2, BL3, BL4, BL5, BL6, BL7, BL8 to AGND, PGND	$V_{NEG} - 0.3$ to $V_{IN} + 0.3$	
	NEG to AGND, PGND	$V_{IN} - 6.0$ to 0.3	
	C1-, C2- to AGND, PGND	$V_{IN} - 6.0$ to 0.3	
	LDOA, LDOB, LDOC, LDOD, SDA, SCL, FLTR, C1+, C2+ to AGND, PGND	-0.3 to $V_{IN} + 0.3$	
$V_{ALS(MAX)}$	Ambient Light Sensor Maximum Input Voltage	V_{IN}	

Thermal Information

Symbol	Description	Value	Units
θ_{JA}	Thermal Resistance ²	67	°C/W
P_D	Maximum Power Dissipation ^{2, 3}	1.5	W
T_A	Operating Temperature Range	-40 to 85	°C
T_J	Junction Temperature Range	-40 to 150	
T_{LEAD}	Maximum Soldering Temperature (at leads, 10 sec.)	300	

1. Stresses above those listed in Absolute Maximum Ratings may cause permanent damage to the device. Functional operation at conditions other than the operating conditions specified is not implied.

2. Mounted on an FR4 board.

3. Derate 15mW/°C above 25°C.

LED Backlight Driver and Multiple LDO Lighting Management Unit

Electrical Characteristics¹

$V_{IN} = 3.6V$; $C_1 = C_2 = 0.22\mu F$; $C_{IN} = C_{NEG} = C_{LDO[B,C,D]} = C_{SBIAS} = 2.2\mu F$; $C_{LDO[A]} = 4.7\mu F$; $T_A = -40^\circ C$ to $85^\circ C$ unless otherwise noted. Typical values are at $T_A = 25^\circ C$.

Symbol	Description	Conditions	Min	Typ	Max	Units	
V_{IN}	Charge Pump Input Operating Voltage Range		2.7		5.5	V	
I_{IN}	IN Operating Current	BL1-BL8=OFF; LDO[A,B,C,D] = OFF via I ² C			600	μA	
		1x mode; LDO[A,B,C,D] = OFF; BL1-BL8 = OFF via I ² C			2	mA	
		1.5x mode; LDO[A,B,C,D] = OFF via I ² C; BL1-BL8 = OPEN		4		6.0	mA
		2x mode; LDO[A,B,C,D] = OFF via I ² C; BL1-BL8 = OPEN		4			mA
		LDO[A,B,C,D] = ON via I ² C; No Load			250		μA
	LDOA = ON; LDO[B,C,D] = OFF via I ² C; No Load			155		μA	
$I_{IN(SHDN)}$	IN Shutdown Current	LDO[A,B,C,D] = OFF via I ² C			1.0	μA	
T_{SD}	Over-Temperature Shutdown Threshold			140		$^\circ C$	
$T_{SD(HYS)}$	Over-Temperature Shutdown Hysteresis			15		$^\circ C$	
Charge Pump Section							
V_{NEG}	NEG Output Voltage	$V_{IN} - V_{NEG}$		5.0		V	
$V_{IN(TH_H, BL)}$	BL1-BL8 Charge Pump Mode Transition Hysteresis	1.5x to 1x Mode Transition		0.3		V	
f_{OSC}	Charge Pump Oscillator Frequency	$T_A = 25^\circ C$	1.17	1.3	1.43	MHz	
$t_{CP(SS)}$	Charge Pump Soft-start Time			100		μs	
BL1-BL8 LED Drivers							
I_{BLx}	BL1-BL8 Current Accuracy	$V_{IN} - V_F = 1V$	18	19.8	22	mA	
		$V_{IN} - V_F = 1V$	1.44	1.8	2.16	mA	
$\frac{\Delta I_{(BLx)}}{I_{BL(AVG)}}$	BL1-BL8 Current Matching ²	$V_{IN} - V_F = 1V$		3		%	
$V_{BL_ (TH)}$	BL1-BL8 Charge Pump Transition Threshold			100		mV	
t_{FADE}	BL1-BL8 Automatic Fade In/Out Timer ³	$V_{IN} - V_F = 1V$	0.75	1	1.25	s	

1. The AAT2870 is guaranteed to meet performance specifications over the $-40^\circ C$ to $+85^\circ C$ operating temperature range and is assured by design, characterization, and correlation with statistical process controls.
 2. Current matching is defined as the deviation of any sink current from the average of all channels.
 3. Guaranteed by f_{osc} .

LED Backlight Driver and Multiple LDO Lighting Management Unit

Electrical Characteristics¹

$V_{IN} = 3.6V$; $C_1 = C_2 = 0.22\mu F$; $C_{IN} = C_{NEG} = C_{LDO[B,C,D]} = C_{SBIAS} = 2.2\mu F$; $C_{LDO[A]} = 4.7\mu F$; $T_A = -40^\circ C$ to $85^\circ C$ unless otherwise noted. Typical values are at $T_A = 25^\circ C$.

Symbol	Description	Conditions	Min	Typ	Max	Units
Linear Regulators						
V_{IN_LDO}	LDO Regulators Input Supply		$V_{OUT} + V_{DO}$		5.5	V
$\Delta V_{LDO[A/B/C/D]} / V_{LDO[A/B/C/D]}$	LDOA, LDOB, LDOC, LDOD Output Voltage Tolerance	$I_{LDO} = 1mA$ to $150mA$; $T_A = 25^\circ C$	-2.0		2.0	%
		$I_{LDO} = 1mA$ to $150mA$; $T_A = -40^\circ C$ to $+85^\circ C$	-3.0		3.0	%
$I_{LDO[A](MAX)}$	LDOA Maximum Load Current		300			mA
$I_{LDO[B/C/D](MAX)}$	LDOB, LDOC LDOD Maximum Load Current		150			mA
$V_{LDO[A](DO)}$	LDOA Dropout Voltage	$V_{LDO[A]} \geq 3.0V$; $I_{OUT} = 300mA$		200		mV
$V_{LDO[B/C/D](DO)}$	LDOB, LDOC, LDOD Dropout Voltage ²	$V_{LDO[B/C/D]} \geq 3.0V$; $I_{OUT} = 150mA$		150		mV
$\Delta V_{LDO} / V_{LDO} * \Delta V_{IN}$	LDOA, LDOB, LDOC, LDOD Line Regulation	$V_{IN} = (V_{LDO[A/B/C/D]} + 1V)$ to $5V$		0.09		%/V
$PSRR_{[A/B/C/D]}$	LDOA, LDOB, LDOC, LDOD Power Supply Rejection Ratio	$I_{LDO[A/B/C/D]} = 10mA$, $1kHz$		50		dB
$R_{LDO_}(DCHG)$	LDOA, LDOB, LDOC, LDOD Auto-Discharge Resistance			1		k Ω
Ambient Light Sensor Interface						
V_{SBIAS}	Ambient Light Sensor Bias Voltage Output Tolerance	$V_{SBIAS} = 3.0V$, $I_{SBIAS} = 200\mu A$	2.85	3.0	3.15	V
		$V_{SBIAS} = 2.6V$, $I_{SBIAS} = 200\mu A$	2.47	2.60	2.73	
$I_{OUT(SBIAS)(MAX)}$	SBIAS Maximum Output Current		30			mA
$V_{ALS(MAX)}$	Ambient Light Sensor Maximum Input Voltage			1.6		V
$I_{IN(ALS)(MAX)}$	ALS ADC Maximum Input Leakage Current				1	μA
$R_{OUT(SBIAS)(DCHG)}$	SBIAS Auto-Discharge Resistance			1		k Ω
Input Threshold Levels – EN, BC_M						
$V_{TH(L)}$	Input Low Threshold				0.4	V
$V_{TH(H)}$	Input High Threshold		1.4			V
I²C Logic and Control Interface						
V_{IL}	SDA, SCL Input Low Threshold	$2.7V \leq V_{IN} \leq 5.5V$			0.4	V
V_{IH}	SDA, SCL Input High Threshold	$2.7V \leq V_{IN} \leq 5.5V$	1.4			V
V_{OL}	SDA Output Low Voltage	$I_{PULL-UP} = 3mA$			0.4	V
I_{IN}	SDA, SCL, EN Input Leakage Current	$V_{SDA} = V_{SCL} = V_{EN} = 5V$	-1		1	μA
f_{SCL}	SCL Clock Frequency		0		400	kHz
t_{LOW}	SCL Clock Low Period		1.3			μs
t_{HIGH}	SCL Clock High Period		0.6			μs
t_{HD_STA}	Hold Time START Condition		0.6			μs
t_{SU_DAT}	SDA Data Setup Time		100			ns
t_{HD_DAT}	SDA Data HOLD Time		0		0.9	μs
t_{SU_STO}	Setup Time for STOP Condition		0.6			μs
t_{BUF}	Bus Free Time Between STOP and START Conditions		1.3			μs

1. The AAT2870 is guaranteed to meet performance specifications over the $-40^\circ C$ to $+85^\circ C$ operating temperature range and is assured by design, characterization, and correlation with statistical process controls.
2. $V_{LDO[A/B/C/D](DO)}$ is defined as $V_{IN} - V_{LDO[A/B/C/D]}$ when $V_{LDO[A/B/C/D]}$ is 98% of nominal.

LED Backlight Driver and Multiple LDO Lighting Management Unit

Typical Characteristics

Input Operating Current, 1x Mode
 ($V_{IN} = 3.6V$; LDOA/B/C/D = OFF; BL1-BL8 = OFF)

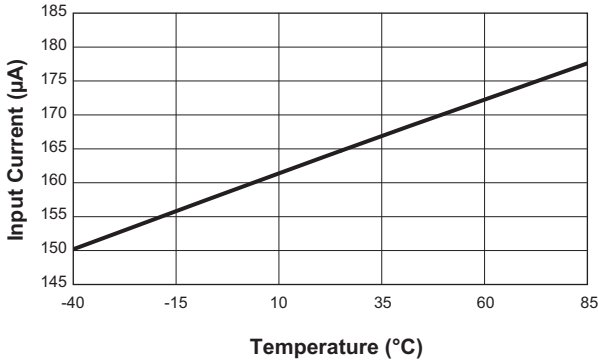

Input Operating Current, 1.5x Mode
 ($V_{IN} = 3.6V$; LDOA/B/C/D = OFF; BL1-BL8 = OPEN)

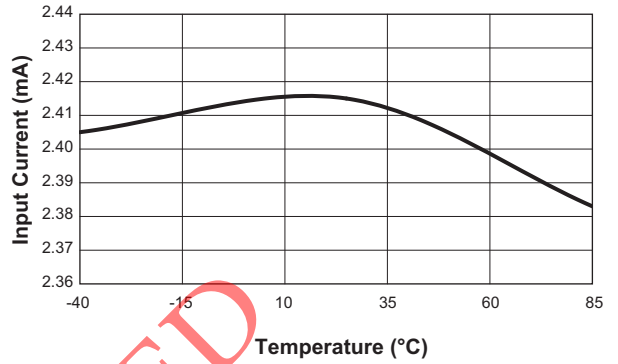

Input Operating Current, 2x Mode
 ($V_{IN} = 3.6V$; LDOA/B/C/D = OFF; BL1-BL8 = OPEN)

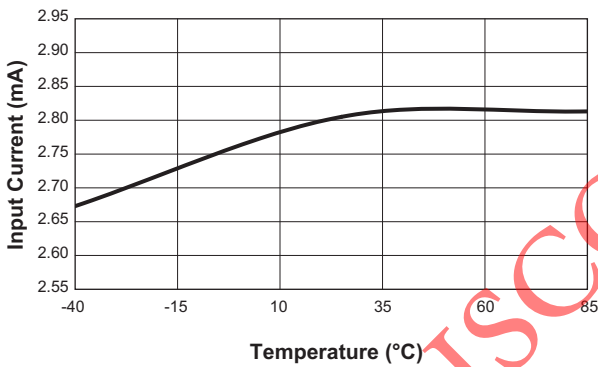

Input Operating Current, All LDOs
 ($V_{IN} = 3.6V$; $V_{LDOA/B/C/D} = 1.2V$; BL1-BL8 = OFF)

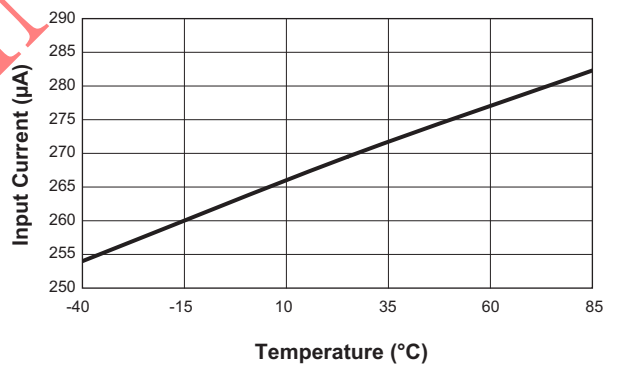

Input Operating Current, Single LDO
 ($V_{IN} = 3.6V$; $V_{LDOA} = 1.2V$; LDOB/C/D = OFF; BL1-BL8 = OFF)

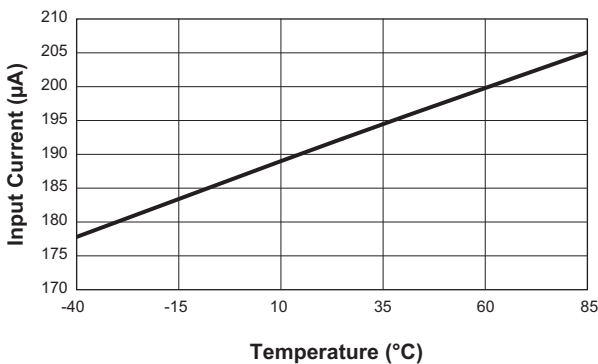

Shutdown Current vs. Temperature
 ($V_{IN} = 3.6V$; EN = GND)

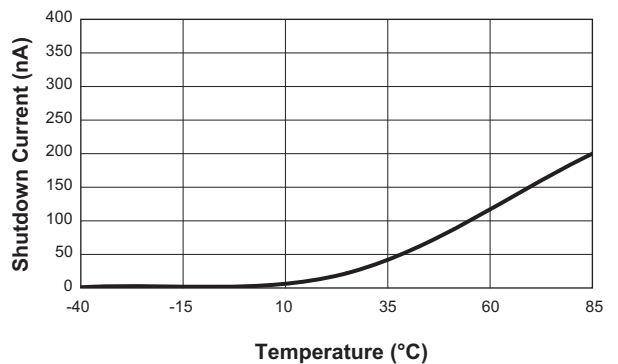

LED Backlight Driver and Multiple LDO Lighting Management Unit

Typical Characteristics

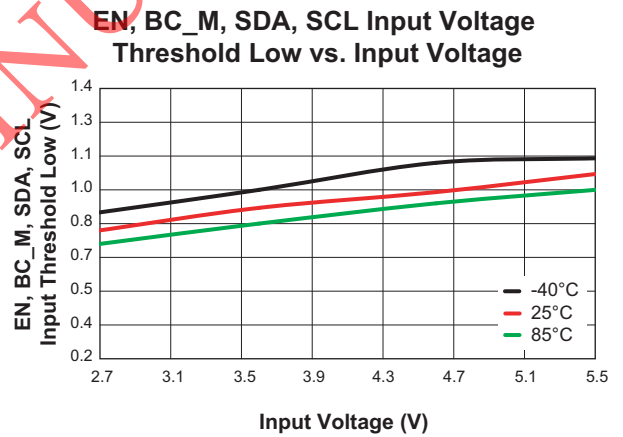
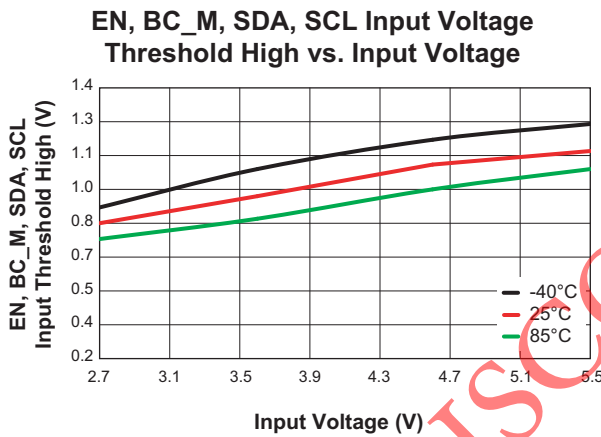
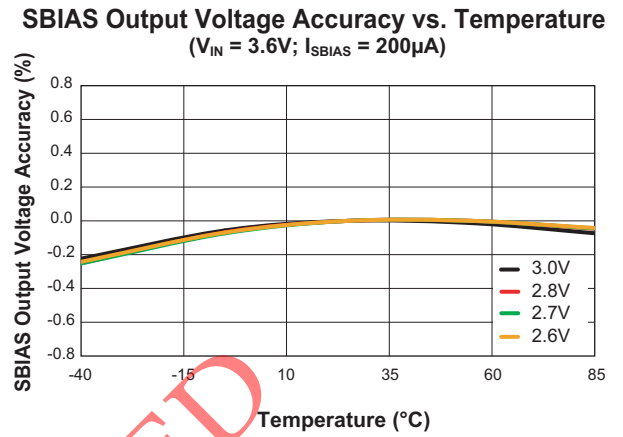
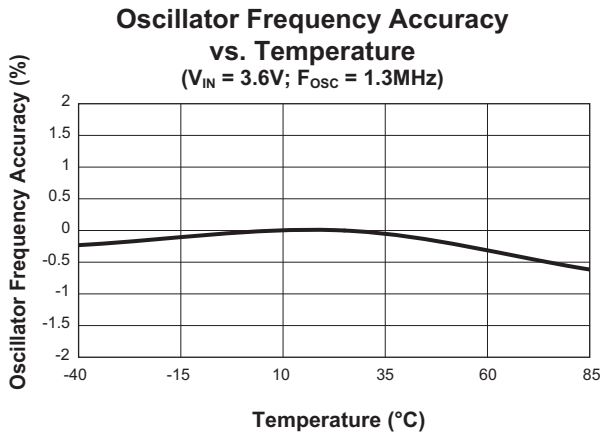

DISCONTINUED

LED Backlight Driver and Multiple LDO Lighting Management Unit

Typical Characteristics

Backlight Efficiency vs. Input Voltage
(Matched LED Forward Voltages)

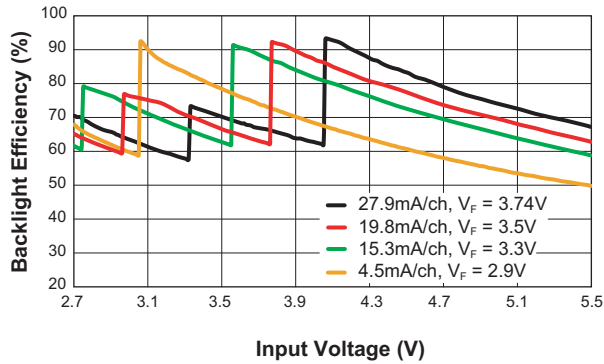

Backlight Efficiency vs. Input Voltage
(Mismatched LED Forward Voltages)

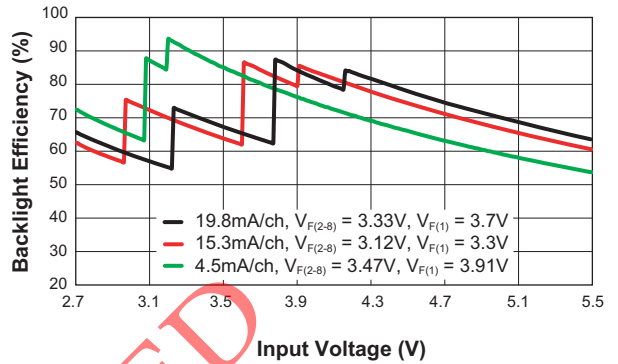

Backlight Current Accuracy vs. Temperature
($I_{BLX} = 19.8\text{mA/ch}$)

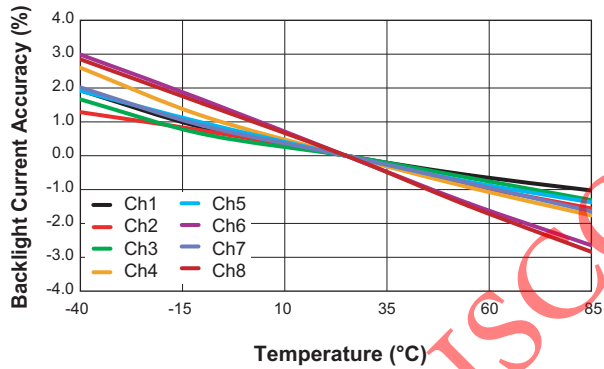

Backlight Current Matching vs. Temperature
($I_{BLX} = 19.8\text{mA/ch}$)

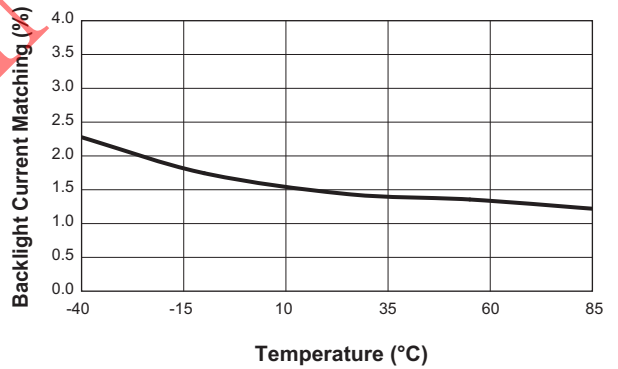

Total Backlight Current vs. BC_M Duty Cycle
($V_{IN} = 3.6\text{V}$; $I_{BLX} = 19.8\text{mA/Ch}$)

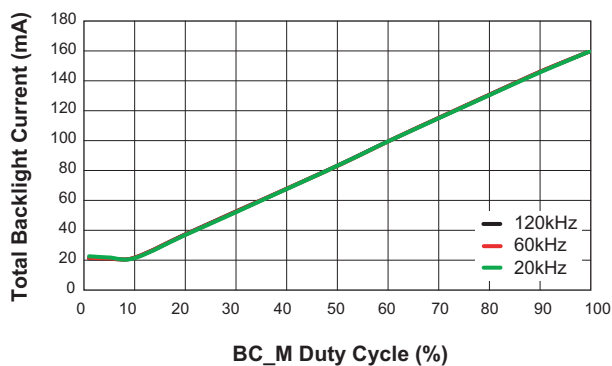

LED Backlight Driver and Multiple LDO Lighting Management Unit

Typical Characteristics

LDOA/B/C/D Output Voltage Accuracy vs. Temperature

($V_{IN} = 3.6V$; $V_{LDOA/B/C/D} = 1.2V$; $I_{LDOA/B/C/D} = 100\mu A$)

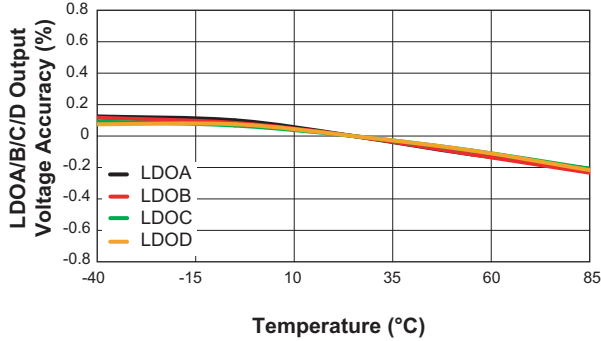

LDOA/B/C/D Output Voltage Accuracy vs. Temperature

($V_{IN} = 3.6V$; $V_{LDOA/B/C/D} = 3.3V$; $I_{LDOA/B/C/D} = 100\mu A$)

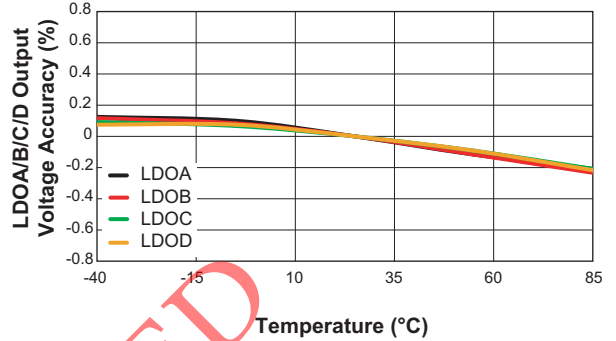

LDOA Output Voltage Load Regulation

($V_{IN} = 3.6V$; $V_{LDOA} = 1.2V$)

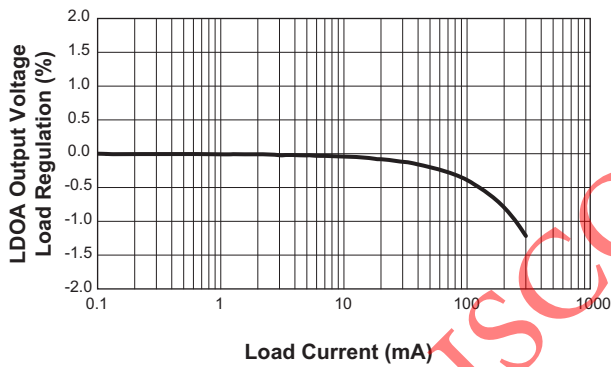

LDOB/C/D Output Voltage Load Regulation

($V_{IN} = 3.6V$; $V_{LDOB/C/D} = 1.2V$)

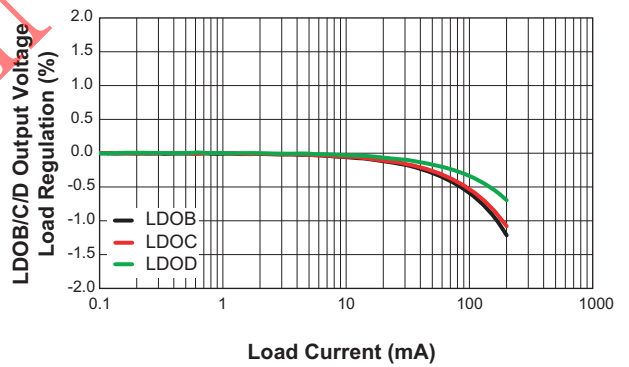

LDOA Output Voltage Load Regulation

($V_{IN} = 3.6V$; $V_{LDOA} = 3.3V$)

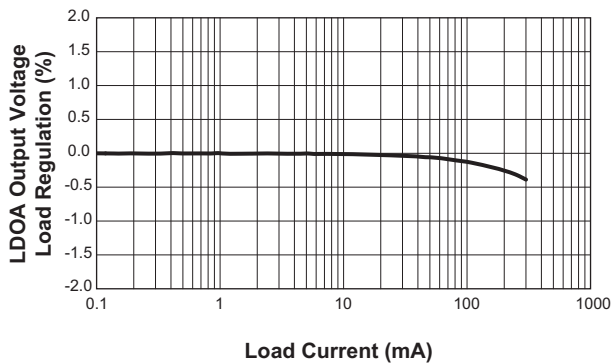

LDOB/C/D Output Voltage Load Regulation

($V_{IN} = 3.6V$; $V_{LDOB/C/D} = 3.3V$)

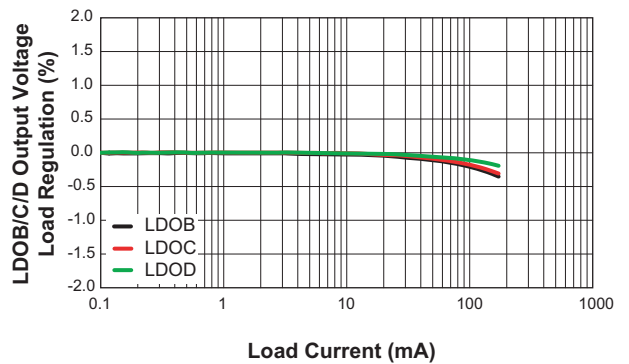

DISCONTINUED

LED Backlight Driver and Multiple LDO Lighting Management Unit

Typical Characteristics

LDOA Output Voltage Line Regulation
 ($V_{LDOA} = 1.2V$; $I_{LDOA} = 20mA$)

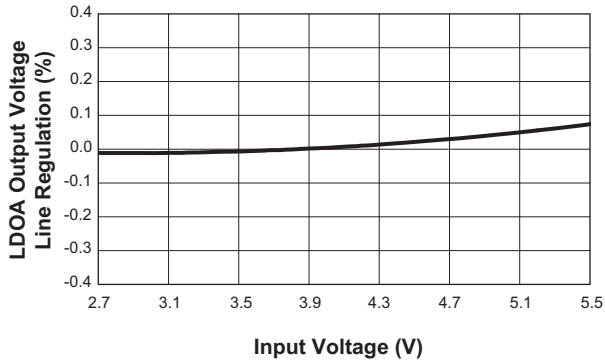

LDOB/C/D Output Voltage Line Regulation
 ($V_{LDOB/C/D} = 1.2V$; $I_{LDOB/C/D} = 10mA$)

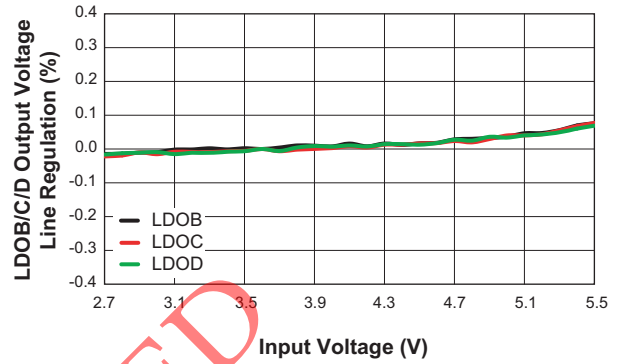

LDOA Output Voltage Line Regulation
 ($V_{LDOA} = 3.3V$; $I_{LDOA} = 20mA$)

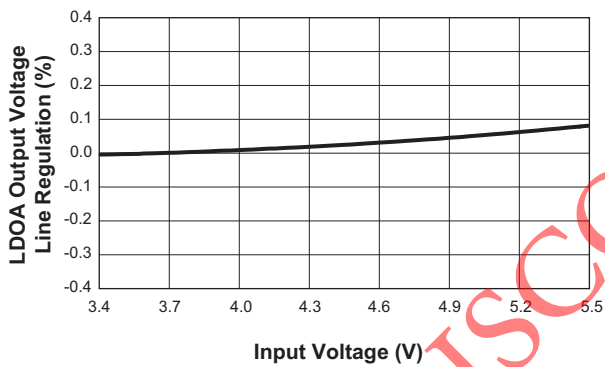

LDOB/C/D Output Voltage Line Regulation
 ($V_{LDOB/C/D} = 3.3V$; $I_{LDOB/C/D} = 10mA$)

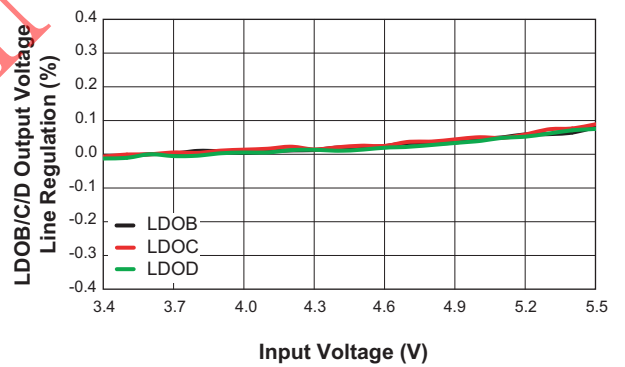

Backlight Turn ON Characteristics, 1x Mode
 ($V_{IN} = 4.2V$; $I_{BLX} = 19.8mA/ch$)

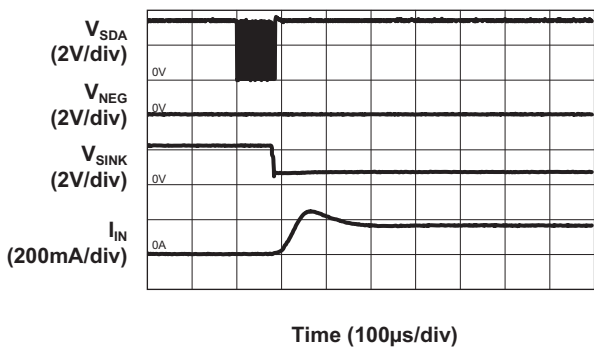

Backlight Turn ON Characteristics, 1.5x Mode
 ($V_{IN} = 3.6V$; $I_{BLX} = 19.8mA/ch$)

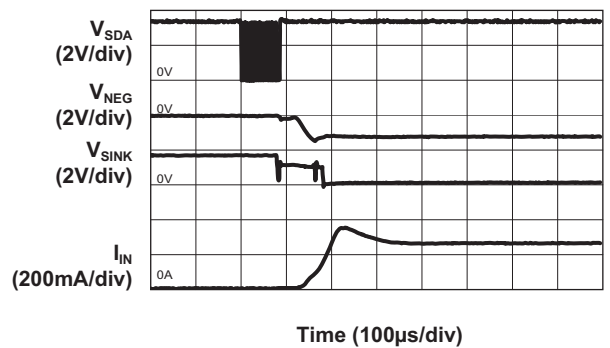

LED Backlight Driver and Multiple LDO Lighting Management Unit

Typical Characteristics

Backlight Turn ON Characteristics, 2x Mode
 $(V_{IN} = 3.0V; I_{BLX} = 19.8mA/ch)$

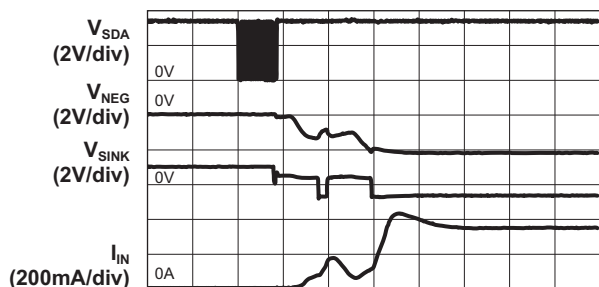

Time (100 μ s/div)

Backlight Turn OFF Characteristics, 1.5x Mode
 $(V_{IN} = 3.6V; I_{BLX} = 19.8mA/ch)$

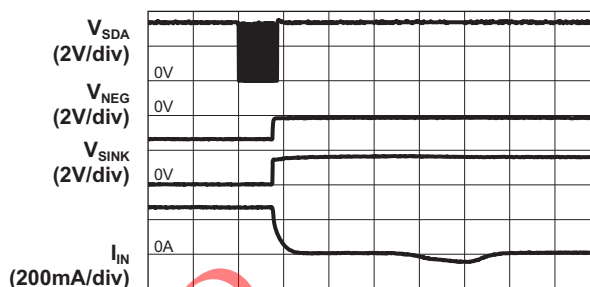

Time (100 μ s/div)

Backlight Operating Characteristics, 1.5X Mode
 $(V_{IN} = 3.6V; I_{BLX} = 19.8mA/ch)$

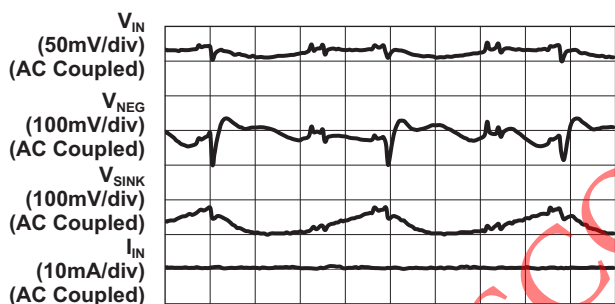

Time (200ns/div)

Backlight Operating Characteristics, 2x Mode
 $(V_{IN} = 2.9; I_{BLX} = 19.8mA/ch)$



Time (200ns/div)

LDOA Line Transient

$(V_{IN} = 3.6V-4.2V; V_{LDOA} = 1.2V; I_{LDOA} = 20mA)$



Time (200 μ s/div)

LDOB/C/D Line Transient

$(V_{IN} = 3.6V-4.2V; V_{LDOB/C/D} = 1.2V; I_{LDOB/C/D} = 10mA)$



Time (200 μ s/div)

LED Backlight Driver and Multiple LDO Lighting Management Unit

Typical Characteristics

LDOA Line Transient

($V_{IN} = 3.6V-4.2V$; $V_{LDOA} = 3.3V$; $I_{LDOA} = 20mA$)

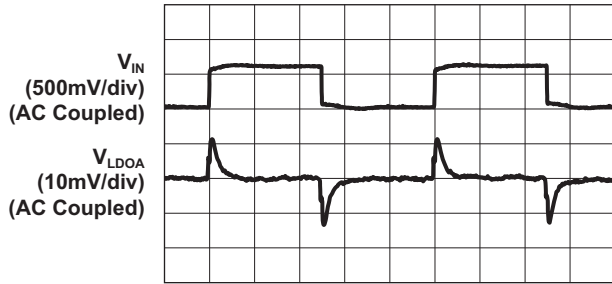

Time (200 μ s/div)

LDOB/C/D Line Transient

($V_{IN} = 3.6V-4.2V$; $V_{LDOB/C/D} = 3.3V$; $I_{LDOB/C/D} = 10mA$)

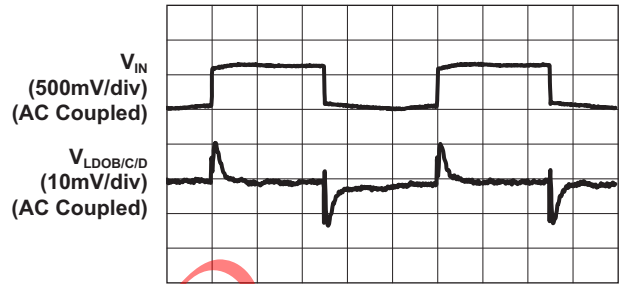

Time (200 μ s/div)

LDOA Load Transient

($V_{IN} = 3.6V$; $V_{LDOA} = 1.2V$; $I_{LDOA} = 10mA-200mA$)

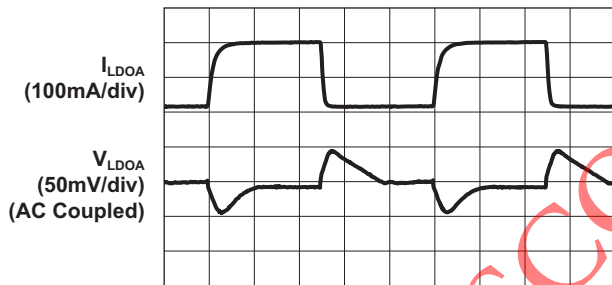

Time (5 μ s/div)

LDOB/C/D Load Transient

($V_{IN} = 3.6V$; $V_{LDOB/C/D} = 1.2V$; $I_{LDOB/C/D} = 10mA-100mA$)

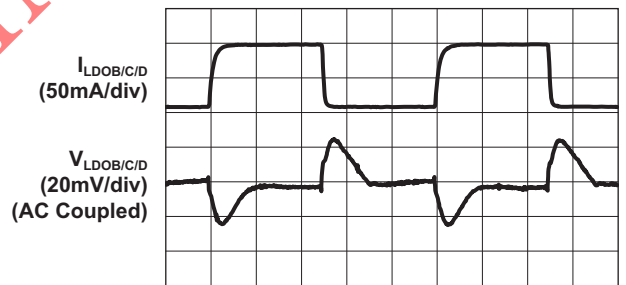

Time (5 μ s/div)

LDOA Load Transient

($V_{IN} = 3.6V$; $V_{LDOA} = 3.3V$; $I_{LDOA} = 10mA-200mA$)

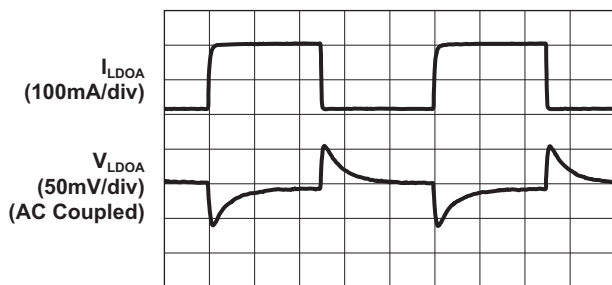

Time (20 μ s/div)

LDOB/C/D Load Transient

($V_{IN} = 3.6V$; $V_{LDOB/C/D} = 3.3V$; $I_{LDOB/C/D} = 10mA-100mA$)

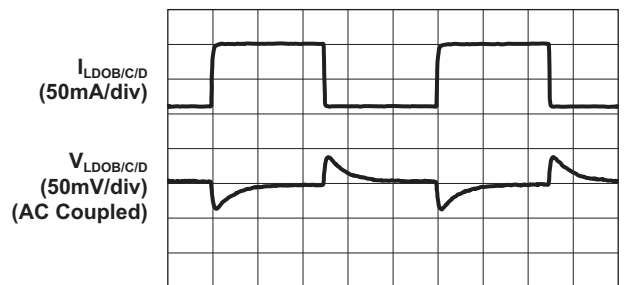

Time (20 μ s/div)

LED Backlight Driver and Multiple LDO Lighting Management Unit

Functional Block Diagram

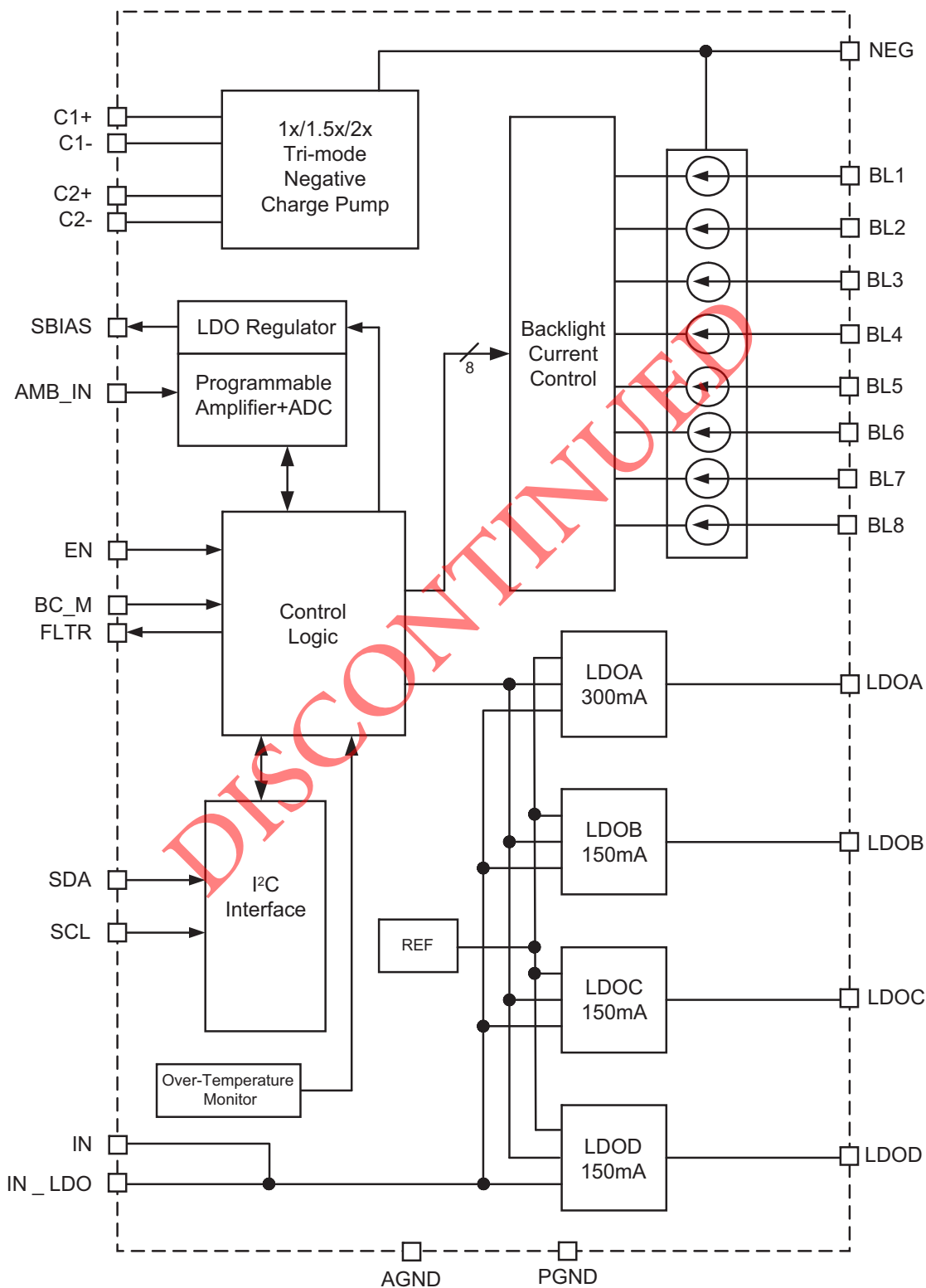

LED Backlight Driver and Multiple LDO Lighting Management Unit

Functional Description

The AAT2870 is a highly integrated display backlight, keypad and auxiliary LED driver with four LDO regulators to power system functions. A negative charge pump delivers improved power conversion efficiency over conventional charge pump devices and drives backlight LEDs from a 2.7V to 5.5V input voltage source. The AAT2870 may be configured to drive any combination of 8 backlight LEDs either individually or in any desired grouping. The AAT2870 is compatible with CABC systems by providing a filtered PWM input for external brightness adjustment based on display content or ambient light conditions. The regulated bias supply output supports ambient light sensors and photo diodes. The integrated ADC polls the ambient light conditions and is readable through the I²C interface. The ambient light control can also be configured to adjust programmed LED current automatically for changing ambient lighting conditions.

In addition to LED backlighting functions, four independent LDO regulators are provided. The LDO regulators produce programmable output voltages between 1.2V and 3.3V. The bi-directional I²C interface provides simple and easy programming of all LED backlight functions, ambient light sensor control and LDO regulator output voltage levels.

LED Drivers

The AAT2870 drives any combination of eight backlight LEDs up to 27.9mA each. The LEDs are independently driven by a negative charge pump circuit to ensure that constant current is maintained for all possible LED forward current and voltage levels over the specified input battery voltage range. The charge pump automatically switches from 1x, 1.5x, or 2x modes to maintain the programmed LED current while minimizing power loss and maximizing power conversion efficiency. To further improve efficiency only the channels that reach the drop-out condition are independently switched to the charge pump supply. The charge pump section operates with a high 1.3MHz switching frequency allowing the use of small external 0.22 μ F¹ ceramic capacitors. By virtue of the negative charge pump, LED anodes are connected directly to the input power source. The programmed forward current for each LED is controlled through individual constant current sinks, allowing for programmable current control with high accuracy over a wide range of

input and LED forward voltages while maintaining high efficiency.

The charge pump is controlled by the voltage across the LED current sinks when programmed for a desired constant current. When any one of the active backlight current sink channels drop below the transition threshold, the charge pump goes to the next higher operating mode (from 1x to 1.5x or from 1.5x to 2x mode) to maintain sufficient LED voltage for a given constant LED current. AAT2870 continuously monitors the LED forward voltages and uses the input voltage to determine when to reduce the charge pump operating mode for better efficiency. There is also a mode-transition hysteresis to maintain charge pump stability between modes.

LED Current Control

The backlight LED constant current levels are controlled through the I²C interface. The backlight LED current can be set between 0.45mA and 27.9mA in approximately 1mA steps. The LED channels may be programmed and enabled globally, in groups of Main, Sub or individually. Backlight fade-in/out and ambient light control functions are configured through the I²C interface. See the "Backlight Current Programming" section for more information.

Ambient Light Sensor Control

The AAT2870 ambient light sensor control circuit provides an interface and control of an external ambient light sensor module or photo diode. The system incorporates a programmable voltage sensor bias supply (SBIAS) which may be configured to output 3.0V, 2.8V, 2.7V or 2.6V and may source up to 30mA. The ALS input has a programmable gain amplifier and ADC which stores one of 16 levels to an internal register to reflect the current calibrated ambient light level. The stored light level data may be read through the bi-directional I²C interface to relay the ambient light information to the system display driver. The ALS circuit may also be configured to directly adjust a preprogrammed backlight LED brightness level based on current ambient light conditions. The ADC continuously filters out the 50Hz and 60Hz flicker noise from indoor lighting, eliminating the need for a large capacitor at the output pin of the ambient light sensor. To save power and improve system efficiency, the ALC circuit features manual polling and automatic polling with programmable polling times.

1. Or alternate value of 1 μ F.

LED Backlight Driver and Multiple LDO Lighting Management Unit

START and STOP Conditions

START and STOP conditions are always generated by the master. Prior to initiating a START, both the SDA and SCL pins are inactive and are pulled high through external pull-up resistors. As shown in Figure 2, a START condition occurs when the master pulls the SDA line low and, after the start condition hold time (t_{HT_STA}), the master strobes the SCL line low. A START condition acts as a signal to all devices on the bus that the device initiating the START sequence is active and will be communicating.

A STOP condition, as shown in Figure 2, occurs when SCL changes from low to high followed after the STOP condi-

tion setup time (t_{SU_STO}), by an SDA low-to-high transition. The master does not issue an ACK and releases SCL and SDA.

Transferring Data

Addresses and data are sent with the most significant bit transmitted first and the least significant bit transmitted last as shown in Figures 3 and 4. After each address or data transmission, the slave device transmits an ACK signal to indicate that it has received the transmission. The ACK signal is generated by the slave after the master releases the SDA data line by driving SDA low.



Figure 2: I²C STOP and START Conditions;
START: A High "1" to Low "0" Transition on the SDA Line While SCL is High "1"
STOP: A Low "0" to High "1" Transition on the SDA Line While SCL is High "1".

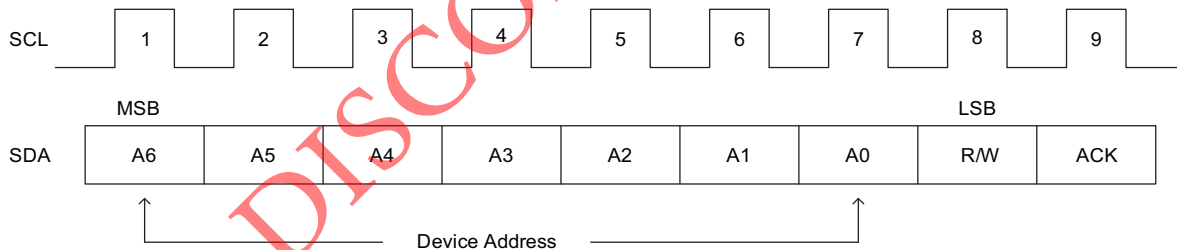

Figure 3: I²C Address Bit Map;
7-bit Slave Address (A6-A0), 1-bit Read/Write (R/W), 1-bit Acknowledge (ACK).

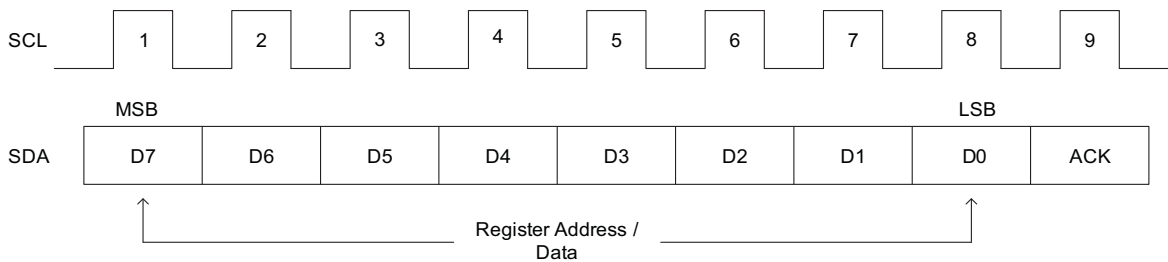

Figure 4: I²C Register Address and Data Bit Map;
8-bit Data (D7-D0), 1-bit Acknowledge (ACK).

LED Backlight Driver and Multiple LDO Lighting Management Unit

Writing to Slave Device

When the Read/Write bit is set to 0 and the address transmitted by the master matches the device address, the slave device transmits an Acknowledge (ACK) signal to indicate that it is ready to receive data. Next, the master transmits the 8-bit register address, and the slave device transmits an ACK to indicate that it received the register address. Next, the master transmits the 8-bit data word, and again the slave device transmits an ACK indicating that it received the data. This process continues until the master is finished writing to the slave device at which time the master generates a STOP condition. A typical AAT2870 I²C write transmission is shown in Figure 5.

Reading from Slave Device

When the Read/Write bit is set to 1 and the address transmitted by the master matches the device address, the slave device transmits an Acknowledge (ACK) signal to indicate that it is ready to receive data. Next, the slave device transmits the 8-bit data word, the master reads the data byte and transmits an ACK to indicate that it received the byte, and generates a STOP condition. An example of AAT2870 I²C read transmission is shown in Figure 6.

Serial Programmed Registers

The AAT2870 has thirty-nine registers listed in Table 1:

- Fourteen for Main/Sub backlight enable, control and configuration of fade in/out function
- Twenty-two for ambient light sensor control and configuration
- Three for LDOs control and configuration

Backlight Current Programming

All eight backlight channels are disabled by default and are assigned as Main backlight. They can easily be programmed in different Main and Sub group configurations by using BLn (03h to 0Ah) registers.

Each channel needs to be enabled by setting EN_CHn=1 from EN_CHn (00h) register. The default setting is 19.8mA per channel.

Fade In/Out Programming

The fade in/out function allows main and sub backlight channels to fade between two programmed current levels in a smooth, logarithmic progression. By default, fade in/out is enabled (bits EN_FM, EN_FS, INIT_FM and INIT_FS have a default value of 1).

The fade in/out function for Main backlight can be disabled by writing EN_FM=0 in FM (0Ch) register and for Sub backlight by writing EN_FS=0 in FS (0Dh) register. The fade function can be interrupted by writing the EN_FM and/or EN_FS bits to 0 while a fade event is in progress. When this happens, the current in the channels will abruptly change to the ceiling value programmed in BLM[4:0] (main channels) or BLS[4:0] (sub channels) registers.

The duration of the fade in/out sequences can be programmed for Main backlight by setting FMT<1:0> in FM (0Ch) register and for Sub backlight by FST<1:0> in FS (0Dh) register. The default fade in/out timing is 1s.

Fade In Function

At initial start up, all Main and Sub backlight channels will turn on with default value of 19.8mA per channel unless fade in has been specifically programmed. The lower current (floor) is programmed using FLRM[3:0] bits from FLR register (for main channels) and bits FLRS[3:0] for sub channels. The default is 0.45mA per channel. The higher current (ceiling) is programmed using bits BLM[4:0] from BLM (01h) register for main channels and bits BLS[4:0] from BLS (02h) register for sub channels.

Fade in sequence for Main backlight is initiated when INIT_FM is changed from 0 to 1 in FM (0Ch) register and for Sub backlight when INIT_FS is changed from 0 to 1 in FS (0Dh) register.

Fade Out Function

The fade out sequence for Main backlight is initiated when INIT_FM is changed from 1 to 0 in FM (0Ch) register and for Sub backlight when INIT_FS is changed from 1 to 0 in FS (0Dh) register.

The floor current will persist until Main/Sub backlight channels are disabled by writing EN_CHn=0 to EN_CHn (00h) register.

AAT2870

LED Backlight Driver and Multiple LDO Lighting Management Unit

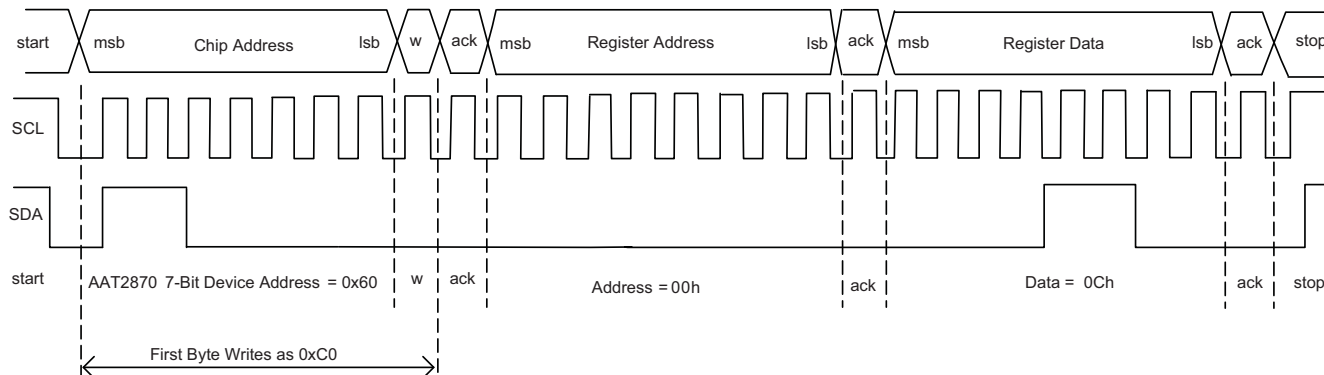

Figure 5: AAT2870 I²C Write Diagram.

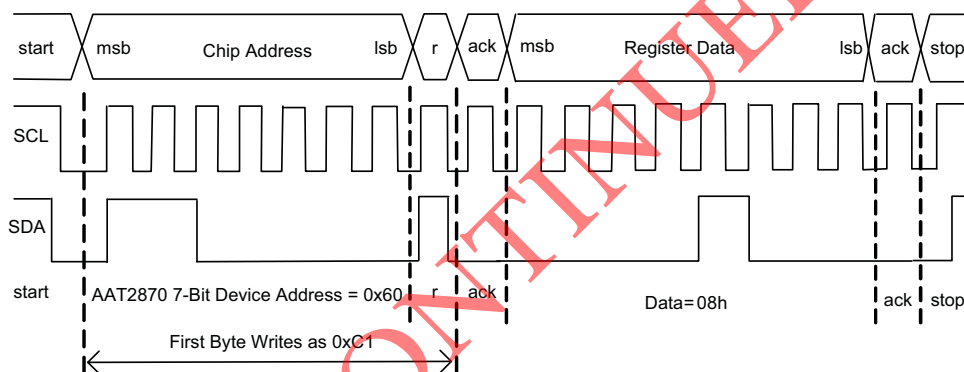

Figure 6: AAT2870 I²C Read Diagram.

DATA SHEET

AAT2870

LED Backlight Driver and Multiple LDO Lighting Management Unit

REG (hex)	Register Name	Bit 7	Bit 6	Bit 5	Bit 4	Bit 3	Bit 2	Bit 1	Bit 0	Description
00h	EN_CHn	EN_CH8	EN_CH7	EN_CH6	EN_CH5	EN_CH4	EN_CH3	EN_CH2	EN_CH1	see Figure 7
01h	BLM				BLM[4]	BLM[3]	BLM[2]	BLM[1]	BLM[0]	see Figure 8
02h	BLS				BLS[4]	BLS[3]	BLS[2]	BLS[1]	BLS[0]	see Figure 9
03h	BL1		MAIN1	SUB1	BL1[4]	BL1[3]	BL1[2]	BL1[1]	BL1[0]	see Figure 10
04h	BL2		MAIN2	SUB2	BL2[4]	BL2[3]	BL2[2]	BL2[1]	BL2[0]	
05h	BL3		MAIN3	SUB3	BL3[4]	BL3[3]	BL3[2]	BL3[1]	BL3[0]	
06h	BL4		MAIN4	SUB4	BL4[4]	BL4[3]	BL4[2]	BL4[1]	BL4[0]	
07h	BL5		MAIN5	SUB5	BL5[4]	BL5[3]	BL5[2]	BL5[1]	BL5[0]	
08h	BL6		MAIN6	SUB6	BL6[4]	BL6[3]	BL6[2]	BL6[1]	BL6[0]	
09h	BL7		MAIN7	SUB7	BL7[4]	BL7[3]	BL7[2]	BL7[1]	BL7[0]	
0Ah	BL8		MAIN8	SUB8	BL8[4]	BL8[3]	BL8[2]	BL8[1]	BL8[0]	
0Bh	FLR	FLRM[3]	FLRM[2]	FLRM[1]	FLRM[0]	FLRS[3]	FLRS[2]	FLRS[1]	FLRS[0]	see Figure 11
0Ch	FM					FMT[1]	FMT[0]	EN_FM	INIT_FM	see Figure 12
0Dh	FS					FST[1]	FST[0]	EN_FS	INIT_FS	see Figure 13
0Eh	ALS_CFG0	SNSR	ALSOUT	RSET[1]	RSET[0]	GAIN[1]	GAIN[0]	GM_SEL	EN_ALS	see Figure 14
0Fh	ALS_CFG1	OS_TM	OS_ADJ[3]	OS_ADJ[2]	OS_ADJ[1]	OS_ADJ[0]	SB[1]	SB[0]	EN_SBIAS	see Figure 15
10h	ALS_CFG2	CABC	PMODE	PTME[1]	PTME[0]	G_ADJ[3]	G_ADJ[2]	G_ADJ[1]	G_ADJ[0]	see Figure 16
11h	AMB	AMB[4]	AMB[3]	AMB[2]	AMB[1]	AMB[0]				see Figure 17
12h	ALS0		ALS0[6]	ALS0[5]	ALS0[4]	ALS0[3]	ALS0[2]	ALS0[1]	ALS0[0]	see Figure 18
13h	ALS1		ALS1[6]	ALS1[5]	ALS1[4]	ALS1[3]	ALS1[2]	ALS1[1]	ALS1[0]	
14h	ALS2		ALS2[6]	ALS2[5]	ALS2[4]	ALS2[3]	ALS2[2]	ALS2[1]	ALS2[0]	
15h	ALS3		ALS3[6]	ALS3[5]	ALS3[4]	ALS3[3]	ALS3[2]	ALS3[1]	ALS3[0]	
16h	ALS4		ALS4[6]	ALS4[5]	ALS4[4]	ALS4[3]	ALS4[2]	ALS4[1]	ALS4[0]	
17h	ALS5		ALS5[6]	ALS5[5]	ALS5[4]	ALS5[3]	ALS5[2]	ALS5[1]	ALS5[0]	
18h	ALS6		ALS6[6]	ALS6[5]	ALS6[4]	ALS6[3]	ALS6[2]	ALS6[1]	ALS6[0]	
19h	ALS7		ALS7[6]	ALS7[5]	ALS7[4]	ALS7[3]	ALS7[2]	ALS7[1]	ALS7[0]	
1Ah	ALS8		ALS8[6]	ALS8[5]	ALS8[4]	ALS8[3]	ALS8[2]	ALS8[1]	ALS8[0]	
1Bh	ALS9		ALS9[6]	ALS9[5]	ALS9[4]	ALS9[3]	ALS9[2]	ALS9[1]	ALS9[0]	
1Ch	ALSA		ALSA[6]	ALSA[5]	ALSA[4]	ALSA[3]	ALSA[2]	ALSA[1]	ALSA[0]	
1Dh	ALSB		ALSB[6]	ALSB[5]	ALSB[4]	ALSB[3]	ALSB[2]	ALSB[1]	ALSB[0]	
1Eh	ALSC		ALSC[6]	ALSC[5]	ALSC[4]	ALSC[3]	ALSC[2]	ALSC[1]	ALSC[0]	
1Fh	ALSD		ALSD[6]	ALSD[5]	ALSD[4]	ALSD[3]	ALSD[2]	ALSD[1]	ALSD[0]	
20h	ALSE		ALSE[6]	ALSE[5]	ALSE[4]	ALSE[3]	ALSE[2]	ALSE[1]	ALSE[0]	
21h	ALSF		ALSF[6]	ALSF[5]	ALSF[4]	ALSF[3]	ALSF[2]	ALSF[1]	ALSF[0]	
22h	SUB_SET	HIGH[3]	HIGH[2]	HIGH[1]	HIGH[0]	LOW[3]	LOW[2]	LOW[1]	LOW[0]	see Figure 19
23h	SUB_CTRL							SUB_RESP	EN_SUB	see Figure 20
24h	LDO_AB	LDOA[3]	LDOA[2]	LDOA[1]	LDOA[0]	LDOB[3]	LDOB[2]	LDOB[1]	LDOB[0]	see Figure 21
25h	LDO_CD	LDOC[3]	LDOC[2]	LDOC[1]	LDOC[0]	LDOD[3]	LDOD[2]	LDOD[1]	LDOD[0]	see Figure 22
26h	EN_LDO	0	0	0	0	EN_LDOD	EN_LDOC	EN_LDOB	EN_LDOA	see Figure 23

Table 1: AAT2870 Configuration/Control Register Allocation.
 ("0" must write 0; Blank space = unassigned)

LED Backlight Driver and Multiple LDO Lighting Management Unit

Backlight Control Registers

EN_CHn: Backlight Channels Enable Register
 (Address 00h, Default 00h)

W-0	W-0	W-0	W-0	W-0	W-0	W-0	W-0 ¹	
EN_CH8	EN_CH7	EN_CH6	EN_CH5	EN_CH4	EN_CH3	EN_CH2	EN_CH1	
							Bit 7	Bit 0

Bit 7 – Bit 0 **EN_CH<8:1>**: Backlight Channels Enable Register

11111111 = All 8 backlight channels are enabled
 00000000 = All 8 backlight channels are disabled

Legend:			
R = Readable bit	W = Writeable bit	U = Unassigned	n = Channel number
-v = Default value	'1' = Bit is set	'0' = Bit is cleared	x = Bit is unknown
1. W-0 means bit 0 is writeable with default value 0			

Figure 7: Backlight Channels Enable Register.

DISCONTINUED

LED Backlight Driver and Multiple LDO Lighting Management Unit

BLM: Main Backlight Control Register
(Address 01h, Default 16h)

U-0	U-0	U-0	W-1	W-0	W-1	W-1	W-0 ¹	
			BLM[4]	BLM[3]	BLM[2]	BLM[1]	BLM[0]	
Bit 7								Bit 0

Bit 7 – Bit 5 **Unassigned**

Bit 4 – Bit 0 **BLM<4:0>**: Main Backlight Current Magnitude

00000	= 0.45 mA
00001	= 0.90 mA
00010	= 1.80 mA
00011	= 2.70 mA
00100	= 3.60 mA
00101	= 4.50 mA
00110	= 5.40 mA
00111	= 6.30 mA
01000	= 7.20 mA
01001	= 8.10 mA
01010	= 9.00 mA
01011	= 9.90 mA
01100	= 10.8 mA
01101	= 11.7 mA
01110	= 12.6 mA
01111	= 13.5 mA
10000	= 14.4 mA
10001	= 15.3 mA
10010	= 16.2 mA
10011	= 17.1 mA
10100	= 18.0 mA
10101	= 18.9 mA
10110	= 19.8 mA
10111	= 20.7 mA
11000	= 21.6 mA
11001	= 22.5 mA
11010	= 23.4 mA
11011	= 24.3 mA
11100	= 25.2 mA
11101	= 26.1 mA
11110	= 27.0 mA
11111	= 27.9 mA

Legend:

R = Readable bit W = Writeable bit U = Unassigned n = Channel number
 -v = Default value '1' = Bit is set '0' = Bit is cleared x = Bit is unknown

1. W-0 means bit 0 is writeable with default value 0

Figure 8: Backlight Main Control Register.

BLS: Sub Backlight Control Register
(Address 02h, Default 16h)

U-0	U-0	U-0	W-1	W-0	W-1	W-1	W-0 ¹	
--	--	--	BLS[4]	BLS[3]	BLS[2]	BLS[1]	BLS[0]	
Bit 7								Bit 0

Bit 7 – Bit 5 **Unassigned**

Bit 4 – Bit 0 **BLS<4:0>**: Sub Backlight Current Magnitude

00000	= 0.45 mA
00001	= 0.90 mA
00010	= 1.80 mA
00011	= 2.70 mA
00100	= 3.60 mA
00101	= 4.50 mA
00110	= 5.40 mA
00111	= 6.30 mA
01000	= 7.20 mA
01001	= 8.10 mA
01010	= 9.00 mA
01011	= 9.90 mA
01100	= 10.8 mA
01101	= 11.7 mA
01110	= 12.6 mA
01111	= 13.5 mA
10000	= 14.4 mA
10001	= 15.3 mA
10010	= 16.2 mA
10011	= 17.1 mA
10100	= 18.0 mA
10101	= 18.9 mA
10110	= 19.8 mA
10111	= 20.7 mA
11000	= 21.6 mA
11001	= 22.5 mA
11010	= 23.4 mA
11011	= 24.3 mA
11100	= 25.2 mA
11101	= 26.1 mA
11110	= 27.0 mA
11111	= 27.9 mA

Legend:

R = Readable bit W = Writeable bit U = Unassigned n = Channel number
 -v = Default value '1' = Bit is set '0' = Bit is cleared x = Bit is unknown

1. W-0 means bit 0 is writeable with default value 0

Figure 9: Sub Backlight Control Register.

LED Backlight Driver and Multiple LDO Lighting Management Unit

BLn: Backlight Channel BLn Individual Control Registers
(Address 03h - 0Ah, Default 56h)

U-0	W-1	W-0	W-1	W-0	W-1	W-1	W-0 ¹
--	MAINn	SUBn	BLn[4]	BLn[3]	BLn[2]	BLn[1]	BLn[0]
Bit 7							Bit 0

Bit 7 **Unassigned**

Bit 6 – Bit 5 **MAINn, SUBn:** Assigns Backlight Channel BLn

- 0 0 = Assigns channel BLn as independent channel
- 1 0 = Assigns channel BLn as part of main group
- 0 1 = Assigns channel BLn as part of sub group
- 1 1 = Assigns channel BLn as part of main group

Bit 4 – Bit 0 **BLn<4:0>:** Backlight Channel BLn Current Magnitude

- 00000 = 0.45 mA
- 00001 = 0.90 mA
- 00010 = 1.80 mA
- 00011 = 2.70 mA
- 00100 = 3.60 mA
- 00101 = 4.50 mA
- 00110 = 5.40 mA
- 00111 = 6.30 mA
- 01000 = 7.20 mA
- 01001 = 8.10 mA
- 01010 = 9.00 mA
- 01011 = 9.90 mA
- 01100 = 10.8 mA
- 01101 = 11.7 mA
- 01110 = 12.6 mA
- 01111 = 13.5 mA
- 10000 = 14.4 mA
- 10001 = 15.3 mA
- 10010 = 16.2 mA
- 10011 = 17.1 mA
- 10100 = 18.0 mA
- 10101 = 18.9 mA
- 10110 = 19.8 mA
- 10111 = 20.7 mA
- 11000 = 21.6 mA
- 11001 = 22.5 mA
- 11010 = 23.4 mA
- 11011 = 24.3 mA
- 11100 = 25.2 mA
- 11101 = 26.1 mA
- 11110 = 27.0 mA
- 11111 = 27.9 mA

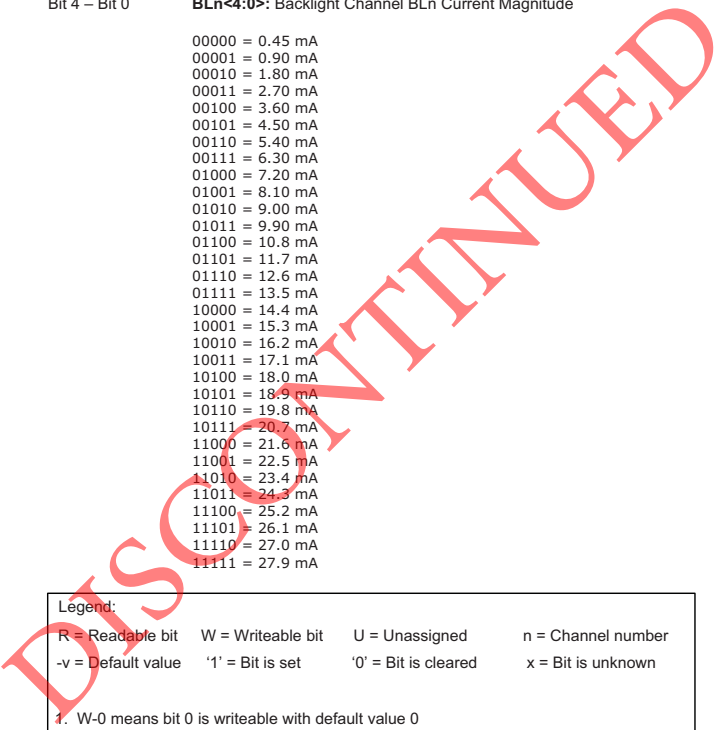

Legend:			
R = Readable bit	W = Writeable bit	U = Unassigned	n = Channel number
-v = Default value	'1' = Bit is set	'0' = Bit is cleared	x = Bit is unknown
1. W-0 means bit 0 is writeable with default value 0			

Figure 10: Individual Backlight Channel Control Registers.

LED Backlight Driver and Multiple LDO Lighting Management Unit

Fade In/Out Control Registers

FLR: Main and Sub Groups Fade In/Out Floor Levels Register
(Address 0Bh, Default 00h)

W-0	W-0	W-0	W-0	W-0	W-0	W-0	W-0 ¹
FLRM[3]	FLRM[2]	FLRM[1]	FLRM[0]	FLRS[3]	FLRS[2]	FLRS[1]	FLRS[0]
Bit 7				Bit 0			

Bit 7 – Bit 4 **FLRM<3:0>**: Main Group Fade In/Out Floor Levels

- 0000 = 0.45 mA
- 0001 = 0.90 mA
- 0010 = 1.80 mA
- 0011 = 2.70 mA
- 0100 = 3.60 mA
- 0101 = 4.50 mA
- 0110 = 5.40 mA
- 0111 = 6.30 mA
- 1000 = 7.20 mA
- 1001 = 8.10 mA
- 1010 = 9.00 mA
- 1011 = 9.90 mA
- 1100 = 10.8 mA
- 1101 = 11.7 mA
- 1110 = 12.6 mA
- 1111 = 13.5 mA

Bit 3 – Bit 0 **FLRS<3:0>**: Sub Group Fade In/Out Floor Levels

- 0000 = 0.45 mA
- 0001 = 0.90 mA
- 0010 = 1.80 mA
- 0011 = 2.70 mA
- 0100 = 3.60 mA
- 0101 = 4.50 mA
- 0110 = 5.40 mA
- 0111 = 6.30 mA
- 1000 = 7.20 mA
- 1001 = 8.10 mA
- 1010 = 9.00 mA
- 1011 = 9.90 mA
- 1100 = 10.8 mA
- 1101 = 11.7 mA
- 1110 = 12.6 mA
- 1111 = 13.5 mA

Legend:

R = Readable bit	W = Writeable bit	U = Unassigned	n = Channel number
-v = Default value	'1' = Bit is set	'0' = Bit is cleared	x = Bit is unknown

1. W-0 means bit 0 is writeable with default value 0

Figure 11: Main and Sub Groups Fade In/Out Floor Levels Register.

LED Backlight Driver and Multiple LDO Lighting Management Unit

FM: Main Group Fade In/Out Control Register
(Address 0Ch, Default 03h)

U-0	U-0	U-0	U-0	W-0	W-0	W-1	W-1 ¹
--	--	--	--	FMT[1]	FMT[0]	EN_FM	INIT_FM

Bit 7 Bit 0

Bit 7 – Bit 4 **Unassigned**

Bit 3 – Bit 2 **FMT<1:0>**: Main Group Fade In/Out Timing

00 = 1.0 sec
01 = 0.8 sec
10 = 0.6 sec
11 = 0.4 sec

Bit 1 **EN_FM**: Main Group Fade In/Out Enable
0 = Fade in/out is enabled for main backlight group
1 = Fade in/out is disabled for main backlight group

Bit 0 **INIT_FM**: Main Group Fade In/Out Initiation
0 = Fade out is initiated for main backlight group
1 = Fade in is initiated for main backlight group

Legend:
R = Readable bit W = Writeable bit U = Unassigned n = Channel number
-v = Default value '1' = Bit is set '0' = Bit is cleared x = Bit is unknown

1. W-1 means bit 0 is writeable with default value 1

FS: Sub Group Fade In/Out Control Register
(Address 0Dh, Default 03h)

U-0	U-0	U-0	U-0	W-0	W-0	W-1	W-1 ¹
--	--	--	--	FST[1]	FST[0]	EN_FS	INIT_FS

Bit 7 Bit 0

Bit 7 – Bit 4 **Unassigned**

Bit 3 – Bit 2 **FST<1:0>**: Sub Group Fade In/Out Timing

00 = 1.0 sec
01 = 0.8 sec
10 = 0.6 sec
11 = 0.4 sec

Bit 1 **EN_FS**: Sub Group Fade In/Out Enable
0 = Fade in/out is enabled for sub backlight group
1 = Fade in/out is disabled for sub backlight group

Bit 0 **INIT_FS**: Sub Group Fade In/Out Initiation
0 = Fade out is initiated for sub backlight group
1 = Fade in is initiated for sub backlight group

Legend:
R = Readable bit W = Writeable bit U = Unassigned n = Channel number
-v = Default value '1' = Bit is set '0' = Bit is cleared x = Bit is unknown

1. W-1 means bit 0 is writeable with default value 1

Figure 12: Main Group Fade In/Out Control Register.

Figure 13: Sub Group Fade In/Out Control Register.

DISCONTINUED

LED Backlight Driver and Multiple LDO Lighting Management Unit

Ambient Light Control Registers

ALS_CFG0: Ambient Light Sensor Gain Selection and Enable Register (Address 0Eh, Default 10h)

W-0	W-0	W-0	W-1	W-0	W-0	W-0	W-0 ¹	
SNSR	ALSOUT	RSET[1]	RSET[0]	GAIN[1]	GAIN[0]	GM_SEL	EN_ALS	
Bit 7								Bit 0

Bit 7 **SNSR**: Analog Ambient Light Sensor Output Selection

- 0 = Linear output
- 1 = Logarithmic output

Bit 6 **ALSOUT**: Digital Ambient Light Sensor Output Selection

- 0 = Linear output
- 1 = Logarithmic output

Bit 5 – Bit 4 **RSET<1:0>**: Ambient Light Sensor Gain Resistor Selection

	Low Gain Resistor (normal ambient brightness)	High Gain Resistor (dim ambient brightness)
00 =	250Ω	1kΩ
01 =	1kΩ	4kΩ
10 =	4kΩ	16kΩ
11 =	16kΩ	64kΩ

Bit 3 – Bit 2 **GAIN<1:0>**: Ambient Light Sensor Input Amplifier Gain Selection

- 00 = Low gain mode
- 01 = High gain mode
- 1X = Fixed gain mode (external resistor is required)

Bit 1 **GM_SEL**: Ambient Light Sensor Gain Mode Selection

- 0 = Auto gain mode
- 1 = Manual gain mode

Bit 0 **EN_ALS**: Ambient Light Sensor (ALS) Enable

- 0 = Disable ambient light sensor
- 1 = Enable ambient light sensor

Legend:			
R = Readable bit	W = Writeable bit	U = Unassigned	n = Channel number
-v = Default value	'1' = Bit is set	'0' = Bit is cleared	x = Bit is unknown
1. W-0 means bit 0 is writeable with default value 0			

Figure 14: Ambient Light Sensor Gain Selection and Enable Register.

LED Backlight Driver and Multiple LDO Lighting Management Unit

ALS_CFG1: Ambient Light Sensor Voltage Bias and Offset Calibration Register (Address 0Fh, Default 06h)

W-0	W-0	W-0	W-0	W-0	W-1	W-1	W-0 ¹
OS_TM	OS_ADJ[3]	OS_ADJ[2]	OS_ADJ[1]	OS_ADJ[0]	SB[1]	SB[0]	EN_SBIAS
Bit 7				Bit 0			

- Bit 7** **OS_TM:** Ambient Light Sensor Output Offset Test Mode Enable
- 0 = Output offset test mode disable
1 = Output offset test mode enable
- Bit 6 – Bit 3** **OS_ADJ<3:0>:** Ambient Light Sensor Output Offset Adjustment
- 0000 = No Adjustment
0001 = +1 LSB
0010 = +2 LSB
0011 = +3 LSB
0100 = +4 LSB
0101 = +5 LSB
0110 = +6 LSB
0111 = +7 LSB
1000 = -8 LSB
1001 = -7 LSB
1010 = -6 LSB
1011 = -5 LSB
1100 = -4 LSB
1101 = -3 LSB
1110 = -2 LSB
1111 = -1 LSB
- Bit 2 – Bit 1** **SB<1:0>:** SBIAS Output Voltage Level Selection
- 00 = 3.0 V
01 = 2.8 V
10 = 2.7 V
11 = 2.6 V
- Bit 0** **EN_SBIAS:** SBIAS Output Enable
- 0 = Disable SBIAS output
1 = Enable SBIAS output

Legend:
R = Readable bit W = Writeable bit U = Unassigned n = Channel number
-v = Default value '1' = Bit is set '0' = Bit is cleared x = Bit is unknown

1. W-0 means bit 0 is writeable with default value 0

Figure 15: Ambient Light Sensor Voltage Bias and Offset Calibration Register.

ALS_CFG2: Ambient Light Sensor Input Gain Adjustment and Polling Time Register (Address 10, Default 00h)

W-0	W-0	W-0	W-0	W-0	W-0	W-0	W-0 ¹
CABC	PMODE	PTIME[1]	PTIME[0]	G_ADJ[3]	G_ADJ[2]	G_ADJ[1]	G_ADJ[0]
Bit 7				Bit 0			

- Bit 7** **CABC:** PWM Input BC_M Mode Enable
- 0 = PWM input is active
1 = PWM input is inactive (operating at maximum duty cycle of 97.5%)
- Bit 6** **PMODE:** Ambient Light Sensor Polling Mode Selection
- 0 = Automatic polling mode
1 = Manual polling mode
- Bit 5 – Bit 4** **PTIME<1:0>:** Ambient Light Sensor Polling Time Selection
- 00 = 0.5 sec
01 = 1.0 sec
10 = 1.5 sec
11 = 2.0 sec
- Bit 3 – Bit 0** **G_ADJ<3:0>:** Ambient Light Sensor Input Gain Adjustment Selection
(refer to "Ambient Light Sensor Gain Adjustment" in the Application Information section for more information)
- 0000 = No Adjustment
0001 = + 6.25 %
0010 = +12.50 %
0011 = +18.75 %
0100 = +25.00 %
0101 = +31.25 %
0110 = +37.50 %
0111 = +43.75 %
1000 = -50.00 %
1001 = -43.75 %
1010 = -37.50 %
1011 = -31.25 %
1100 = -25.00 %
1101 = -18.75 %
1110 = -12.50 %
1111 = -6.25 %

Legend:
R = Readable bit W = Writeable bit U = Unassigned n = Channel number
-v = Default value '1' = Bit is set '0' = Bit is cleared x = Bit is unknown

1. W-0 means bit 0 is writeable with default value 0

Figure 16: Ambient Light Sensor Input Gain Adjustment and Polling Time Register.

LED Backlight Driver and Multiple LDO Lighting Management Unit

AMB: Ambient Light Sensor Digital Output Read Data Register
 (Address 11h, Default 00h)

R-0	R-0	R-0	R-0	R-0	U-0	U-0	U-0 ¹
AMB[4]	AMB[3]	AMB[2]	AMB[1]	AMB[0]	--	--	--
Bit 7					Bit 0		

Bit 7 – Bit 3

AMB<4:0>: Ambient Light Sensor Read Data

Normal Mode	Register Reading	ALS Output Level
00000000 =	00h	0
00001000 =	08h	+1
00010000 =	10h	+2
00011000 =	18h	+3
00100000 =	20h	+4
00101000 =	28h	+5
00110000 =	30h	+6
00111000 =	38h	+7
01000000 =	40h	+8
01001000 =	48h	+9
01010000 =	50h	+10
01011000 =	58h	+11
01100000 =	60h	+12
01101000 =	68h	+13
01110000 =	70h	+14
01111000 =	78h	+15

Test Mode Only	Register Reading	ALS Output Level
11111000 =	F8h	-1
11110000 =	F0h	-2
11101000 =	E8h	-3
11100000 =	E0h	-4
11011000 =	D8h	-5
11010000 =	D0h	-6
11001000 =	C8h	-7
11000000 =	C0h	-8
10111000 =	B8h	-9
10110000 =	B0h	-10
10101000 =	A8h	-11
10100000 =	A0h	-12
10011000 =	98h	-13
10010000 =	90h	-14
10001000 =	88h	-15
10000000 =	80h	-16

Bit 2 – Bit 0 **Unassigned**

Legend:			
R = Readable bit	W = Writeable bit	U = Unassigned	n = Channel number
-v = Default value	'1' = Bit is set	'0' = Bit is cleared	x = Bit is unknown
1. U-0 means bit 0 is unassigned and read as 0			

Figure 17: Ambient Light Sensor Digital Output Read Data Register.

LED Backlight Driver and Multiple LDO Lighting Management Unit

ALS_n: Ambient Light Sensor Controlled Current Dimming Levels Programming Registers
(Address 12h – Address 21h, Default 00h)

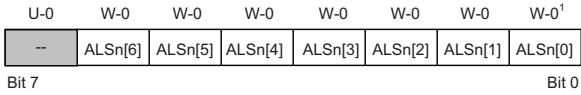

Bit 7 **Unassigned**

Bit 6 – Bit 0 **ALS_n<6:0>**: Ambient Light Sensor Controlled Current Dimming Levels Selection

	LED Current (Log)	LED Current (mA)	Brightness (Lux)
0000100 =	0.00	0.90	64
0000101 =	0.10	1.13	91
0000111 =	0.19	1.58	130
0001001 =	0.29	2.03	185
0001011 =	0.39	2.48	263
0001110 =	0.49	3.15	374
0010001 =	0.58	3.83	532
0010101 =	0.68	4.73	758
0011011 =	0.78	6.08	1079
0100010 =	0.88	7.65	1535
0101010 =	0.97	9.45	2185
0110100 =	1.07	11.70	3111
1000001 =	1.17	14.63	4428
1010010 =	1.26	18.45	6303
1100110 =	1.36	22.95	8971
1111111 =	1.46	27.9	12770

Legend:

R = Readable bit W = Writeable bit U = Unassigned n = Channel number
 -v = Default value '1' = Bit is set '0' = Bit is cleared x = Bit is unknown

1. W-0 means bit 0 is writeable with default value 0

Figure 18: Ambient Light Sensor Controlled Current Dimming Levels Programming Registers.

SUB_SET: Sub Group ALS Response Thresholds Register
(Address 22h, Default 00h)

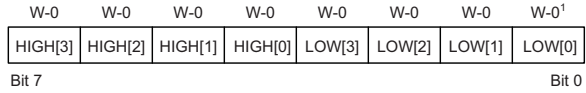

Bit 7 – Bit 4 **HIGH<3:0>**: Sub Group ALS Response High Threshold

0000 – Minimum high threshold
1111 – Maximum high threshold

Bit 3 – Bit 0 **LOW<3:0>**: Sub Group ALS Response Low Threshold

0000 – Minimum low threshold
1111 – Maximum low threshold

(Refer to "Sub Group Response to Ambient Light Sensor Data Reading" in the Application Information section for additional information)

Legend:

R = Readable bit W = Writeable bit U = Unassigned n = Channel number
 -v = Default value '1' = Bit is set '0' = Bit is cleared x = Bit is unknown

1. W-0 means bit 0 is writeable with default value 0

Figure 19: Sub Group ALS Response Thresholds Register.

LED Backlight Driver and Multiple LDO Lighting Management Unit

SUB_CTRL: Sub Group Response to ALS Output Register (Address 23h, Default 00h)

U-0	U-0	U-0	U-0	U-0	U-0	W-0	W-0 ¹
--	--	--	--	--	--	SUB_RESP	EN_SUB
Bit 7						Bit 0	

Bit 7 – Bit 2 **Unassigned**

Bit 1 **SUB_RESP:** Sub Group Response to ALS Read Data
(refer to “Sub Group Response to Ambient Light Sensor Data Reading” in the Application Information section for additional information)

- 0 = Dimming response
- 1 = Brightening response

Bit 0 **EN_SUB:** Sub Group Response to ALS Read Data Enable

- 0 = Sub group response is disabled
- 1 = Sub group response is enabled

Legend:			
R = Readable bit	W = Writeable bit	U = Unassigned	n = Channel number
-v = Default value	'1' = Bit is set	'0' = Bit is cleared	x = Bit is unknown
1. W-0 means bit 0 is writeable with default value 0			

Figure 20: Sub Group Response To ALS Output Register.

DISCONTINUED

LED Backlight Driver and Multiple LDO Lighting Management Unit

LDO Regulators Control Registers

LDOAB: LDOA and LDOB Output Voltage Level Programming Register (Address 24h, Default 00h)

W-0	W-0	W-0	W-0	W-0	W-0	W-0	W-0 ¹
LDOA[3]	LDOA[2]	LDOA[1]	LDOA[0]	LDOB[3]	LDOB[2]	LDOB[1]	LDOB[0]
Bit 7				Bit 0			

Bit 7 – Bit 4 **LDOA<3:0>**: LDOA Output Voltage Level Selection

0000 = 1.2 V
 0001 = 1.3 V
 0010 = 1.5 V
 0011 = 1.6 V
 0100 = 1.8 V
 0101 = 2.0V
 0110 = 2.2 V
 0111 = 2.5 V
 1000 = 2.6 V
 1001 = 2.7 V
 1010 = 2.8 V
 1011 = 2.9 V
 1100 = 3.0 V
 1101 = 3.1 V
 1110 = 3.2 V
 1111 = 3.3 V

Bit 3 – Bit 0 **LDOB<3:0>**: LDOB Output Voltage Level Selection

0000 = 1.2 V
 0001 = 1.3 V
 0010 = 1.5 V
 0011 = 1.6 V
 0100 = 1.8 V
 0101 = 2.0 V
 0110 = 2.2 V
 0111 = 2.5 V
 1000 = 2.6 V
 1001 = 2.7 V
 1010 = 2.8 V
 1011 = 2.9 V
 1100 = 3.0 V
 1101 = 3.1 V
 1110 = 3.2 V
 1111 = 3.3 V

Legend:

R = Readable bit W = Writeable bit U = Unassigned n = Channel number
 -v = Default value '1' = Bit is set '0' = Bit is cleared x = Bit is unknown

1. W-0 means bit 0 is writeable with default value 0

Figure 21: LDOA/LDOB Output Voltage Level Programming Register.

LDOCD: LDOC and LDOD Output Voltage Level Programming Register (Address 25h, Default 00h)

W-0	W-0	W-0	W-0	W-0	W-0	W-0	W-0 ¹
LDOC[3]	LDOC[2]	LDOC[1]	LDOC[0]	LDOD[3]	LDOD[2]	LDOD[1]	LDOD[0]
Bit 7				Bit 0			

Bit 7 – Bit 4 **LDOC<3:0>**: LDOC Output Voltage Level Selection

0000 = 1.2 V
 0001 = 1.3 V
 0010 = 1.5 V
 0011 = 1.6 V
 0100 = 1.8 V
 0101 = 2.0 V
 0110 = 2.2 V
 0111 = 2.5 V
 1000 = 2.6 V
 1001 = 2.7 V
 1010 = 2.8 V
 1011 = 2.9 V
 1100 = 3.0 V
 1101 = 3.1 V
 1110 = 3.2 V
 1111 = 3.3 V

Bit 3 – Bit 0 **LDOD<3:0>**: LDOD Output Voltage Level Selection

0000 = 1.2 V
 0001 = 1.3 V
 0010 = 1.5 V
 0011 = 1.6 V
 0100 = 1.8 V
 0101 = 2.0 V
 0110 = 2.2 V
 0111 = 2.5 V
 1000 = 2.6 V
 1001 = 2.7 V
 1010 = 2.8 V
 1011 = 2.9 V
 1100 = 3.0 V
 1101 = 3.1 V
 1110 = 3.2 V
 1111 = 3.3 V

Legend:

R = Readable bit W = Writeable bit U = Unassigned n = Channel number
 -v = Default value '1' = Bit is set '0' = Bit is cleared x = Bit is unknown

1. W-0 means bit 0 is writeable with default value 0

Figure 22: LDOC/LDOD Output Voltage Level Programming Register.

LED Backlight Driver and Multiple LDO Lighting Management Unit

EN_LDO: LDOA/B/C/D Output Enable Register
(Address 26h, Default 00h)

W-0	W-0	W-0	W-0	W-0	W-0	W-0	W-0 ¹
0	0	0	0	EN_LDOD	EN_LDOC	EN_LDOB	EN_LDOA
Bit 7				Bit 0			

Bit 7 – Bit 4 **Must be programmed as 0**

Bit 3 **EN_LDOD: LDOD Output Enable**

0 = LDOD output is disabled
1 = LDOD output is enabled

Bit 2 **EN_LDOC: LDOC Output Enable**

0 = LDOC output is disabled
1 = LDOC output is enabled

Bit 1 **EN_LDOB: LDOB Output Enable**

0 = LDOB output is disabled
1 = LDOB output is enabled

Bit 0 **EN_LDOA: LDOA Output Enable**

0 = LDOA output is disabled
1 = LDOA output is enabled

Legend:			
R = Readable bit	W = Writeable bit	U = Unassigned	n = Channel number
-v = Default value	'1' = Bit is set	'0' = Bit is cleared	x = Bit is unknown
1. W-0 means bit 0 is writeable with default value 0			

Figure 23: LDO Output Enable Register.

LED Backlight Driver and Multiple LDO Lighting Management Unit

Applications Information

Ambient Light Sensor (ALS)

An ambient-light sensor is used to measure the brightness of the surrounding environment. Based on the brightness level, the AAT2870 can adjust the backlight LED current, leading to longer battery life and comfortable viewing with less eyestrain. The AAT2870 works with a wide range of sensors presently on the market and can perform the gain-adjustment function to correct the part-to-part output variation of an ambient-light sensor.

Some typical values of the luminance in different environments are given below as reference points:

- Moonlight: 0.2 to 1 Lux
- Candlelight: 5 Lux
- Streetlight: 10 Lux
- Office light: 300 to 1000 Lux
- Daylight (not direct sun): 10,000 Lux
- Direct sunlight: 100,000 Lux

Ambient-light sensors used in smart phone applications are often placed underneath a light pipe and a glass cover. The actual light brightness reaching the ambient-light sensor must be determined before choosing an ambient-light sensor.

Ambient-Light Sensor Selection

The types of ambient-light sensors on the market include photodiodes, photo-transistors, and photo-ICs; all these types of sensors generate current or voltage output signals. Ambient light sensors with current outputs require a resistor placed at the output to convert the current into voltage. Figure 24 shows the current output of an ambient-light sensor, which is linear or logarithmic to the light brightness in Lux.

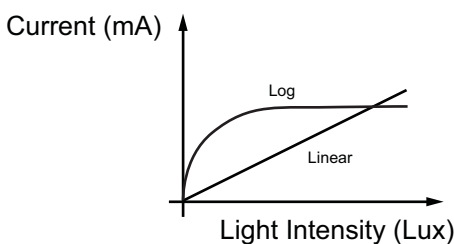

Figure 24: Ambient-Light Sensor with Linear or Log Output Current.

Some ambient-light sensors provide logarithmic or square-root outputs. If an ambient-light sensor with linear output is used while a logarithmic output is desired, the AAT2870 can convert a linear ALS output to logarithmic output by setting SNSR = 0 of register ALS_CFG0(0Eh) and setting ALSOUT = 1 as shown in Figure 15.

Ambient-Light Sensor Evaluation

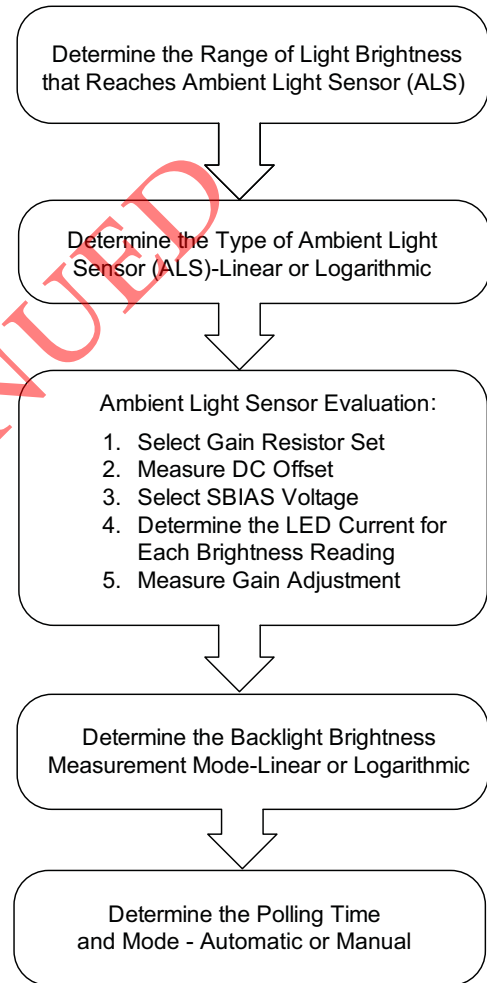

Figure 25: Ambient Light Sensor Configuration Flowchart.

LED Backlight Driver and Multiple LDO Lighting Management Unit

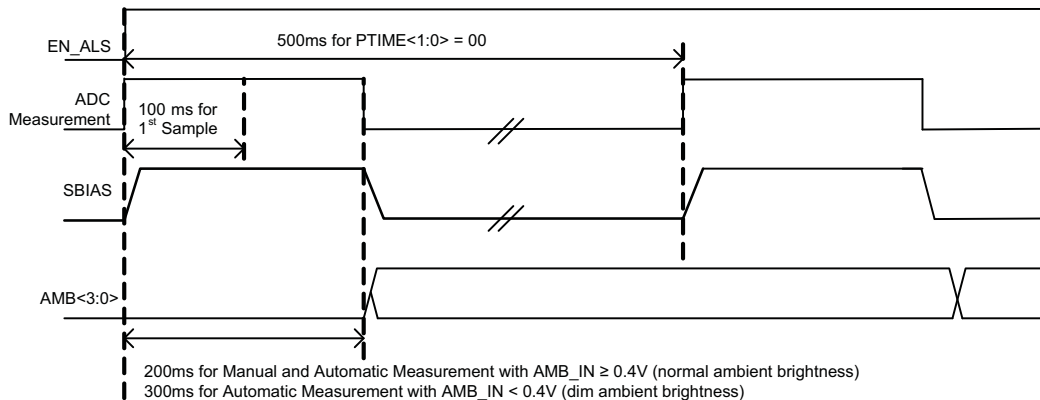

Figure 26: Ambient Light Sensor A/D Conversion Timing Diagram.

Ambient Light Sensor Gain Resistor Selection

When an ambient-light sensor with current output is selected, a load resistor is used to convert the output current into an output voltage. The AAT2870 provides a set of four internal resistor pairs that are listed in Figure 14. An external resistor can be used if none of the integrated resistor pairs fit the application requirement.

Example 1: The light luminance on the ambient-light sensor is from 0 Lux to 10,000 Lux. If the output current of an ambient-light sensor is 4µA per 100 Lux, then the resistor required to cover the whole luminance range can be calculated as follows:

$$\text{Low-gain resistor} = \frac{1.6\text{V Full-Scale}}{\left(\frac{4\mu\text{A} \cdot 10000\text{ Lux}}{100\text{ Lux}}\right)} = 4\text{k}\Omega$$

The chosen resistor set is 4kΩ, 16kΩ.

Ambient Light Sensor Offset Adjustment

Any leakage current present will cause an offset at the output of the ambient light sensor, leading to inaccurate measurement of the light brightness. However, this offset can be corrected by programming bits OS_ADJ<3:0> from register ALS_CFG1 (0Fh) of the AAT2870. The four allocated bits provide offset correction from -8LSB to +7LSB, as shown in Figure 15.

The DC offset of the ambient-light-sensor output can be measured with the AAT2870. The AAT2870 is powered up and enabled with a power supply or a battery; the ambient-light-sensor is then enabled by writing EN_ALS=1 to the ALS_CFG0 (0Eh) register (see Figure 14). The voltage bias for the ambient light sensor needs to be enabled as well by writing EN_SBIAS=1 to the ALS_CFG1 (0Fh) register (see Figure 15). The test mode measurement of the ambient light sensor offset is commenced when writing OS_TM=1 to the ALS_CFG1 (0Fh) register.

Example 2: The procedure to determine the ambient-light-sensor offset is explained below, assuming a resistor set of 4kΩ, 16kΩ is used:

- Connect the SBIAS pin of AAT2870 to the input voltage pin of an ambient-light sensor, and connect the AMB_IN pin of AAT2870 to the output pin of the ambient-light sensor.
- The BH1600FVC ambient light sensor by Rohm is used with the AAT2870 demo board (Figures 32 and 33). Depending on how much light goes through the light pipe and reaches the ambient-light sensor, the GC1 and GC2 setting can be determined. If the range of light is up to 10,000 Lux, the L-Gain mode should be chosen by connecting GC1 to GND and GC2 to SBIAS. If the range of light is up to 3,000 Lux or lower, then the H-Gain mode should be chosen by connecting GC1 to SBIAS and GC2 to GND. The difference between H-Gain mode and L-Gain mode is the amount of output current from the ambient-light sensor (see Table 6).

LED Backlight Driver and Multiple LDO Lighting Management Unit

- The AAT2870's ambient light sensor amplifier is set to auto gain mode. The part will automatically choose the 4kΩ low-gain resistor when the ambient light is bright and the 16kΩ high-gain resistor when the ambient light is dim for better accuracy.
- To power up the AAT2870, set enable pin EN = High and BC_M = High.
- Start ambient light sensor offset measurement by writing the following commands to the AAT2870:
 1. Write AAT2870 7-bit I²C address: 0x60 (first byte writes as C0h, binary 11000000).
 2. Enable all backlight channels by writing to register EN_CHn (00h) data FFh.
 3. Choose linear ambient light sensor gain mode and internal gain resistor pair by writing to register ALS_CFG0 (0Eh) data 21h.
 4. Enable SBIAS in offset test mode by writing to register ALS_CFG1 (0Fh) data 81h (*Note: During normal operation, offset test-mode should be turned off by setting bit OS_TM=0 in ALS_CFG1 (0Fh) register as shown in Figure 15).*
- Read the AMB (11h) register for the ambient-light sensor output offset. Although the AMB register has eight bits, only bits AMB[3:0] should be captured; bit AMB[4] is a sign (+ or -) bit. Refer to Figure 17 for a complete list of readings.
- Convert the 5-bit offset to a 4-bit offset according to Table 3. The 4-bit offset with opposite sign needs to be written to OS_ADJ<3:0> from ALS_CFG1 (0Fh) register during normal operation. *Note: If the 5-bit offset reading is F8h (binary 11111000), then the output offset of the ambient-light sensor is -1LSB. It can be converted to 1111 in 4 bits. In order to adjust this ambient-light sensor offset, a +1 LSB offset needs to be added, by writing 0001 to OS_ADJ<3:0> of the ALS_CFG1 (0Fh) register during normal operation. For complete list of offset adjustments see Table 2.*

ALS_CFG1: Ambient Light Sensor Voltage Bias and Offset Calibration Control Register									
ALS 4-Bit Offset Measurement in Test Mode					ALS 4-Bit Offset Adjustment in Normal Mode				
OS_ADJ[3]	OS_ADJ[2]	OS_ADJ[1]	OS_ADJ[0]	Offset	OS_ADJ[3]	OS_ADJ[2]	OS_ADJ[1]	OS_ADJ[0]	Offset
0	0	0	0	0	0	0	0	0	0
0	0	0	1	+1	1	1	1	1	-1
0	0	1	0	+2	1	1	1	0	-2
0	0	1	1	+3	1	1	0	1	-3
1	1	0	0	+4	1	1	0	0	-4
1	1	0	1	+5	1	0	1	1	-5
1	1	1	0	+6	1	0	1	0	-6
1	1	1	1	+7	1	0	0	1	-7
Offset too high					1	0	0	0	-8
1	0	0	0	-8	Offset too high				
1	0	0	1	-7	0	1	1	1	+7
1	0	1	0	-6	0	1	1	0	+6
1	0	1	1	-5	0	1	0	1	+5
1	1	0	0	-4	0	1	0	0	+4
1	1	0	1	-3	0	0	0	1	+3
1	1	1	0	-2	0	0	1	0	+2
1	1	1	1	-1	0	0	0	1	+1

Table 2: Ambient Light Sensor 4-Bit Offset Adjustment.

AAT2870

LED Backlight Driver and Multiple LDO Lighting Management Unit

AMB: Ambient Light Sensor Digital Output Read Data Register					ALS_CFG1: Ambient Light Sensor Voltage Bias and Offset Calibration Register				
ALS 5-Bit Offset Measurement in Test Mode					ALS 4-Bit Offset Measurement in Test Mode				
AMB[4]	AMB[3]	AMB[2]	AMB[1]	AMB[0]	OS_ADJ[3]	OS_ADJ[2]	OS_ADJ[1]	OS_ADJ[0]	Offset
0	0	0	0	0	0	0	0	0	0
0	0	0	0	1	0	0	0	1	+1
0	0	0	1	0	0	0	1	0	+2
0	0	0	1	1	0	0	1	1	+3
0	0	1	0	0	0	1	0	0	+4
0	0	1	0	1	0	1	0	1	+5
0	0	1	1	0	0	1	1	0	+6
0	0	1	1	1	0	1	1	1	+7
0	1	0	0	0	Offset too high				
0	1	0	0	1	Offset too high				
0	1	0	1	0	Offset too high				
0	1	0	1	1	Offset too high				
0	1	1	0	0	Offset too high				
0	1	1	0	1	Offset too high				
0	1	1	1	0	Offset too high				
0	1	1	1	1	Offset too high				
1	0	0	0	0	Offset too high				
1	0	0	0	1	Offset too high				
1	0	0	1	0	Offset too high				
1	0	0	1	1	Offset too high				
1	0	1	0	0	Offset too high				
1	0	1	0	1	Offset too high				
1	0	1	1	0	Offset too high				
1	0	1	1	1	Offset too high				
1	1	0	0	0	1	0	0	0	-8
1	1	0	0	1	1	0	0	1	-7
1	1	0	1	0	1	0	1	0	-6
1	1	0	1	1	1	0	1	1	-5
1	1	1	0	0	1	1	0	0	-4
1	1	1	0	1	1	1	0	1	-3
1	1	1	1	0	1	1	1	0	-2
1	1	1	1	1	1	1	1	1	-1

Table 3: Ambient Light Sensor 5-Bit to 4-Bit Offset Conversion.

LED Backlight Driver and Multiple LDO Lighting Management Unit

Ambient Light Sensor Gain Adjustment

For the majority of ambient-light sensors, the part-to-part variation of the output current is guaranteed to be $\pm 20\%$ at best. More expensive ambient-light sensors can guarantee $\pm 10\%$ output accuracy. Tolerances in light pipes and ambient light sensors limit the output current accuracy to only $\pm 35\%$. AAT2870 allows the customer to choose an inexpensive ambient-light sensor while offering a $\pm 10\%$ part-to-part variation by providing an automatic calibrating gain adjustment from -50% to $+43.75\%$ for any off-the-shelf ambient-light sensor.

Figure 27 shows the ideal ambient-light sensor output versus light brightness after gain-adjustment calibration.

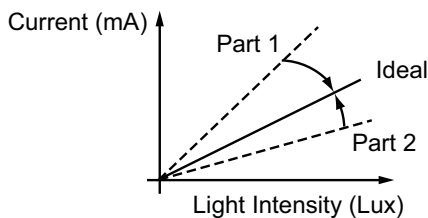

Figure 27: Ambient-Light Sensor Output Current with Gain Variation.

The maximum AMB_IN input voltage is 2.4V with -37.5% gain adjustment. For optimal performance the minimum output voltage of an ambient-light sensor needs to be higher than the adjusted AMB_IN input voltage with an extra 6.25% headroom, or 2.55V according to Table 4.

Ambient Light Sensor Voltage Bias

The external ambient light sensor is powered by the SBIAS output, which is a programmable voltage linear regulator that provides up to 30mA for the sensor bias. The SBIAS output voltage may be programmed and enabled by both the ambient light sensor control register ALS_CFG0 (Figure 14) and by the ambient light sensor voltage bias control register ALS_CFG1 (Figure 15). The SBIAS voltage can be selected from 2.6V up to 3V by writing bits SB<1:0> of the ALS_CFG1 (0Fh) register.

The SBIAS voltage is determined based on the full-scale negative gain adjustment necessary to achieve optimal performance. The relationship between the AMB_IN voltage input full scale without adjustment (Ideal Full-Scale), the gain adjustment (Gain_ADJ), and the adjusted AMB_IN scale (Adjusted Full-Scale) can be expressed in the following equation:

$$\text{Adjusted Full-Scale} = \frac{\text{Ideal Full-Scale}}{1 + \text{Gain_ADJ}}$$

The minimum saturated output voltage of the BH1600FVC ambient light sensor is 2.6V with 3.0V supply voltage; therefore, a SBIAS voltage of 3V should be selected for this particular case.

If the calculated AMB_IN maximum voltage exceeds 3V an external voltage source is recommended.

G_ADJ[3:0]	Gain Adjustment (%)	AMB_IN Full Scale (V)	ALS_CFG2 (10h)	AMB_IN Min (V)	AMB_IN Max (V)
0111	43.75	1.08	07h	1.01	1.15
0110	37.50	1.14	06h	1.07	1.21
0101	31.25	1.18	05h	1.11	1.25
0100	25.00	1.25	04h	1.17	1.33
0011	18.75	1.31	03h	1.23	1.39
0010	12.50	1.37	02h	1.28	1.46
0001	6.25	1.44	01h	1.35	1.53
0000	0	1.56	00h	1.46	1.66
1111	-6.25	1.65	0Fh	1.55	1.75
1110	-12.50	1.75	0Eh	1.64	1.86
1101	-18.75	1.86	0Dh	1.74	1.98
1100	-25.00	2.02	0Ch	1.89	2.15
1011	-31.25	2.21	0Bh	2.07	2.35
1010	-37.50	2.40	0Ah	2.25	2.55
1001	-43.75	2.68	09h	2.51	2.85
1000	-50.00	3.05	08h	2.86	3.24

Table 4: Ambient Light Sensor Gain Adjustment.

LED Backlight Driver and Multiple LDO Lighting Management Unit

Backlight LED Current Settings for Different Brightness Readings

The main recipient of the light emitted by all visible-spectrum LEDs is the human eye. It responds to light luminance in a non-linear logarithmic way. The sensitivity of the human eye decreases rapidly as the luminance of the source increases. The LED current needs to change logarithmically in relation to the light brightness in order for the light brightness to be perceived as linear by the human eye.

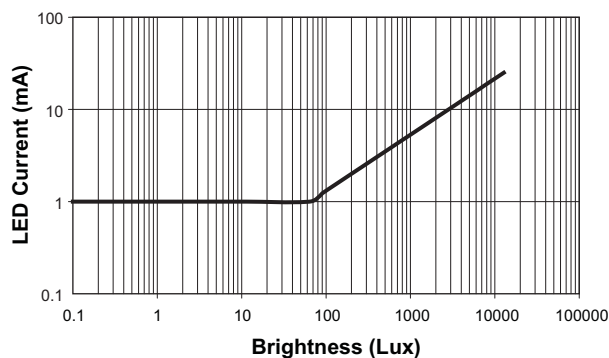

Figure 28: Backlight LED Current vs. Light Brightness.

The AAT2870 has sixteen default LED current setting levels programmed in ALSn (from 12h to 21h) registers. These sixteen current level settings follow the logarithmic trend shown in Figure 28. A linear ambient light sensor output and a linear output brightness are set by using the default setting of SNSR=0 and ALSOUT=0 of the ALS_CFG0 (0Eh) register. For each light brightness sampling, one of the current levels corresponding to the ambient light reading will be selected to control the backlight LED current.

If the desired current settings are different than the default, the user can change them by writing to ALSn (12h through 21h) registers.

Ambient Light Sensor Brightness Gain Mode

AAT2870 allows automatic and manual modes for measurement of the ambient light sensor brightness. The automatic gain mode is selected by default value GM_SEL=0 in ALS_CFG0 (0Eh) register. For better accuracy during automatic mode the AAT2870 will choose low gain resistor when the ambient light is bright and high gain resistor when the ambient light is dim.

For the manual gain mode, all light brightness measurements are completed with the low gain resistor as set by GM_SEL=1 of the ALS_CFG0 (0Eh) register.

Ambient Light Sensor Brightness Polling Time

The AAT2870 offers two bits for programming the ambient light sensor brightness polling time. There are four different polling times: 0.5s, 1s, 1.5s and 2s selected by writing PTIME<1:0> bits of the ALS_CFG2 (10h) register.

If an automatic ambient light sensor polling mode is selected by default PMODE=0 of ALS_CFG2 (10h) register, AAT2870 will periodically update the information about the surrounding brightness at every elapsed time interval. Refer to Figure 26 for A/D conversion timing diagram. Manual ambient sensor polling mode can also be selected by writing PMODE=1 to ALS_CFG2 (10h) register.

Sub Group Response to Ambient Light Sensor Output Reading

All Sub group channels can be programmed to respond to the brightness of the surrounding environment independent of the Main group. The Sub group response is enabled by programming bit EN_SUB=1 from the SUB_CTRL (23h) register. The high and low thresholds for the Sub group can be set by writing to the SUB_SET (22h) register. In the SUB_SET (22h) register bits HIGH[3:0] are dedicated for programming the high threshold and bits LOW[3:0] for the low threshold. Depending on the actual application (auxiliary display, keypad, etc.) the Sub group response can be programmed in two ways:

LED Backlight Driver and Multiple LDO Lighting Management Unit

1. Dimming response: set by SUB_RESP=0 (default) from SUB_CTRL (23h) register.

If the ambient light sensor reading indicates the surrounding environment is brighter than the high threshold $AMB[3:0] > HIGH[3:0]$ then the Sub backlight steps down to preset floor level (default 0.45mA per channel).

If the ambient light sensor reading indicates the surrounding environment is dimmer than the low threshold $AMB[3:0] < LOW[3:0]$ then the Sub backlight brightness is stepped up to preset ceiling level (default 19.8mA per channel).

This mode is recommended for keypad backlighting applications.

2. Brightening response: set by SUB_RESP=1 from SUB_CTRL (23h) register.

If the ambient light sensor reading indicates the surrounding environment is brighter than the high threshold ($AMB[3:0] > HIGH[3:0]$) then the Sub backlight brightness is stepped up to preset ceiling level.

If the ambient light sensor reading indicates the surrounding environment is dimmer than the low threshold $AMB[3:0] < LOW[3:0]$ then the Sub backlight brightness is stepped down to preset floor level.

This mode is recommended for auxiliary display backlighting applications.

When the Sub group response to ambient light sensor output read data is enabled (EN_SUB=1 from the SUB_CTRL register), then EN_FS and INIT_FS bits in the FS (0Dh) register are masked and the Sub group will stop responding to any fade in/out programming.

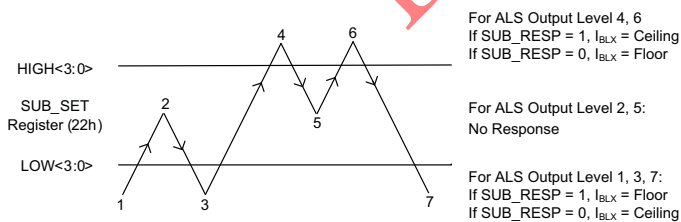

Figure 29: Sub Group Response to Ambient Light Sensor Output Reading.

AAT2870 Programming Examples

Example 1: Ambient Light Sensor Linear Brightness Readings and Logarithmic Backlight Response

SNSR=0: Linear Measurement

ALSOUT=0: Linear Output

Backlight Current: Logarithmic Response

Brightness (Lux)	LED Current (mA)
1 -- 64	0.9
64 -- 10000	0.9 to 28.6 in log scale

Table 5: Sensor Requirements for Example 1.

Ambient light sensor model BH1600FVC by Rohm is used for all examples:

Mode	GC1	GC2	Current μ A/100Lux
H-Gain Mode	1	0	60
L-Gain Mode	0	1	6.31

Table 6: Rohm BH1600FVC Ambient Light Sensor Output Current Level.

Parameter	Value
Maximum Brightness (Lux)	10000
Floor Brightness (Lux)	64
ALS Output (μ A/10 Lux)	0.63
Gain Resistor (K Ω)	4
Gain Adjustment (%)	-18.75
AMB-IN Full-Scale (V)	1.92
Maximum. LED Current (mA)	28.60
Floor Current (mA)	0.9
Brightness / Floor	156.25
Log (Brightness / Floor)	2.19
Log current per level	0.10
Brightness / Level	662.4
k factor	0.68

Table 7: Determination of LED Current vs. Brightness in a Logarithmic Relationship.

LED Backlight Driver and Multiple LDO Lighting Management Unit

$$\text{Eq. 1: } \frac{\text{Log} \left(\frac{\text{Brightness}}{\text{Floor}} \right)}{15} = 0.15$$

Set up description:

Ambient light sensor model BH1600FVC from Rohm is used with the AAT2870 demo board (Figures 33 and 34). The demo board jumper P3 controls the gain setting GC2 and jumper P4 controls the gain setting GC1. Pin 1 (logic 1) on the jumpers P3 and P4 is designated by the square pad in Figure 34.

- Select low gain ALS output (GC1=0, GC2=1)
- Resistor set of 4KΩ, 16KΩ is calculated for the application
- All backlight channels are enabled as MAIN group
- Ambient light sensor has no DC offset
- Ambient light sensor gain adjustment is -18.75%
- Linear ALSOUT is selected

- SBIAS = 3.0V is selected
- Light brightness is measured at 1s time intervals
- Read register AMB (11h).
- Default settings are used for ALSn (12h to 21h) registers.

The following commands need to be communicated to AAT2870 through I²C:

- Write AAT2870 7-bit I²C address: 0x60 (first byte writes as C0h; binary 110000)
- Write to register EN_CHn (00h) data FFh
- Write to register ALS_CFG0 (0Eh) data 21h
- Write to register ALS_CFG1 (0Fh) data 01h
- Write to register ALS_CFG2 (10h) data 0Dh
- Read register AMB (11h); bits AMB[3:0] indicate the ambient light brightness level; first byte writes as C1h; all readings are listed in Table 8. AMB[4] is the sign (+ or -) bit.

ALS Read Data Register AMB (11h) (LOG Output)	Light Brightness (Lux)	Log of Brightness/Floor Level	LED Current (mA)	AMB_IN Voltage (mV)	Register Address (Hex)	Register Data (Dec)	Register Data (Hex)	Register Data (Binary)
0	64	0.00	0.9	13.10	12	4	4	0000100
1	726	0.10	1.1	148.73	13	5	5	0000101
2	1389	0.20	1.4	284.36	14	6	6	0000110
3	2051	0.30	1.8	419.98	15	8	8	0001000
4	2714	0.40	2.3	555.61	16	10	A	0001010
5	3376	0.50	2.9	691.24	17	13	D	0001101
6	4038	0.60	3.6	826.86	18	16	10	0010000
7	4701	0.70	4.5	962.49	19	20	14	0010100
8	5363	0.80	5.7	1098.12	1A	25	19	0011001
9	6026	0.90	7.2	1233.74	1B	32	20	0100000
10	6688	1.00	9.0	1369.37	1C	40	28	0101000
11	7350	1.10	11.4	1504.99	1D	51	33	0110011
12	8013	1.20	14.3	1640.62	1E	64	40	1000000
13	8675	1.30	18.0	1776.25	1F	80	50	1010000
14	9338	1.40	22.7	1911.87	20	101	65	1100101
15	10000	1.50	28.6	2047.50	21	127	7F	1111111

Table 8: Ambient Light Sensor Linear Brightness Readings and Logarithmic Backlight Response.

LED Backlight Driver and Multiple LDO Lighting Management Unit

Example 2: Ambient Light Sensor Linear Brightness Readings and Linear Backlight Response

SNSR=0: Linear Measurement

ALSOUT =0: Linear Output

Backlight Current: Linear Response

Brightness (Lux)	LED Current (mA)
1 -- 40	5
40 -- 10000	5 to 20

Table 9: Sensor Requirements for Example 2.

Parameter	Value
Maximum Brightness (Lux)	10000
Floor Brightness (Lux)	40
ALS Output (μ A/10 Lux)	0.63
Gain Resistor (K Ω)	4
Gain Adjustment (%)	-18.75
AMB-IN Full-Scale (V)	1.92
Maximum LED Current (mA)	20
Floor Current (mA)	5
Brightness per Level (Lux)	664
LED Current per Level (mA)	1

Table 10: Determination of LED Current vs. Brightness in a Logarithmic Relationship.

GC2	GC1	Mode
0	0	Shutdown
0	1	H-Gain Mode
1	0	L-Gain Mode
1	1	Test Mode (input prohibition)

Table 11: Rohm BH1600FVC Ambient Light Sensor Mode Settings.

Set up description:

Ambient light sensor model BH1600FVC from Rohm is used with the AAT2870 demo board (Figures 33 and 34). The demo board jumper P3 controls the gain setting GC2 and jumper P4 controls the gain setting GC1. Pin 1 (logic 1) on the jumpers P3 and P4 is designated by the square pad in Figure 34.

- Select low gain ALS output (GC1=0, GC2=1) (see Table 11)
- A resistor set of 4K Ω , 16K Ω is calculated for the application
- All backlight channels are enabled as MAIN group
- Ambient light sensor has no DC offset
- Ambient light sensor gain adjustment is -18.75%
- Linear ALSOUT is selected
- SBIAS = 3.0V is selected
- Light brightness is measured at 1s time intervals
- Read register AMB (11h)
- Write to ALSn (12h to 21h) registers the data

The following commands need to be communicated to AAT2870 through I²C:

- Write AAT2870 7-bit I²C address: 0x60 (binary 110000, first byte writes as C0h)
- Write to register EN_CHn (00h) data FFh
- Write to register ALS_CFG0 (0Eh) data 21h
- Write to register ALS_CFG1 (0Fh) data 01h
- Write to register ALS_CFG2 (10h) data 0Dh
- Read register AMB (11h); bits AMB[3:0] indicate the ambient light brightness level; first byte writes as C1h; all readings are listed in Table 12
- Write to register ALS0 (12h) data 16h
- Write to register ALS1 (13h) data 1Bh
- Write to register ALS2 (14h) data 1Fh
- Write to register ALS3 (15h) data 24h
- Write to register ALS4 (16h) data 28h
- Write to register ALS5 (17h) data 2Ch
- Write to register ALS6 (18h) data 31h
- Write to register ALS7 (19h) data 35h
- Write to register ALS8 (1Ah) data 3Ah
- Write to register ALS9 (1Bh) data 3Eh
- Write to register ALSA (1Ch) data 43h
- Write to register ALSB (1Dh) data 47h
- Write to register ALSC (1Eh) data 4Ch
- Write to register ALSD (1Fh) data 50h
- Write to register ALSE (20h) data 54h
- Write to register ALSF (21h) data 59h

LED Backlight Driver and Multiple LDO Lighting Management Unit

ALS Read Data Register AMB (11h) (LOG Output)	Light Brightness (Lux)	LED Current (mA)	AMB_IN Voltage (mV)	Register Address (Hex)	Register Data (Dec)	Register Data (Hex)	Register Data (Binary)
0	40	5.0	8.19	12h	22	16h	0010110
1	704	6.0	144.14	13h	27	1Bh	0011011
2	1368	7.0	280.10	14h	31	1Fh	0011111
3	2032	8.0	416.05	15h	36	24h	0100100
4	2696	9.0	552.01	16h	40	28h	0101000
5	3360	10.0	687.96	17h	44	2Ch	0101100
6	4024	11.0	823.91	18h	49	31h	0110001
7	4688	12.0	959.87	19h	53	35h	0110101
8	5352	13.0	1095.82	1Ah	58	3Ah	0111010
9	6016	14.0	1231.78	1Bh	62	3Eh	0111110
10	6680	15.0	1367.73	1Ch	67	43h	1000011
11	7344	16.0	1503.68	1Dh	71	47h	1000111
12	8008	17.0	1639.64	1Eh	76	4Ch	1001100
13	8672	18.0	1775.59	1Fh	80	50h	1010000
14	9336	19.0	1911.55	20h	84	54h	1010100
15	10000	20.0	2047.50	21h	89	59h	1011001

Table 12: Ambient Light Sensor Linear Brightness Readings and Linear Backlight Response.

Example 3: Ambient Light Sensor Logarithmic Brightness and Logarithmic Backlight Response

SNSR =0: Linear Measurement
 ALSOUT=1: Logarithmic Output
 Backlight Current: Logarithmic Response

Brightness (Lux)	LED Current (mA)
1 - 10	5
10 - 100	10
100 - 1000	15
1000 - 10000	20

Table 13: Sensor Requirements for Example 3.

Parameter	Value
Maximum Brightness (Lux)	1000
Floor Brightness (Lux)	40
ALS Output (µA / 10 Lux)	6
Gain Resistor (KΩ)	4
Gain Adjustment (%)	-18.75
AMB-IN Full-Scale (V)	1.92
Maximum LED Current (mA)	20
Floor Current (mA)	5
Brightness / Floor	25
Log(Brightness / Floor)	1.40
Log current per level	0.04
k factor	0.43

Table 14: Determination of LED Current vs. Brightness in a Logarithmic Relationship.

$$\text{Eq. 2: } \frac{\log\left(\frac{\text{Brightness}}{\text{Floor}}\right)}{15} = 0.09$$

LED Backlight Driver and Multiple LDO Lighting Management Unit

Set up description:

Ambient light sensor model BH1600FVC from Rohm is used with the AAT2870 demo board (Figures 33 and 34). The demo board jumper P3 controls the gain setting GC2 and jumper P4 controls the gain setting GC1. Pin 1 (logic 1) on the jumpers P3 and P4 is designated by the square pad in Figure 34.

- Select high gain ALS output (GC1=1, GC2=0) (see Table 11).
- Resistor set of 4K Ω , 16K Ω is calculated for the application
- All backlight channels are enabled as MAIN group
- Ambient light sensor has no DC offset
- Ambient light sensor gain adjustment is -18.75%
- Logarithmic ALSOUT is selected
- SBIAS = 3.0V is selected
- Light brightness is measured at 1s time intervals
- Read register AMB (11h)
- Write to registers ALSn (12h to 21h) the data

The following commands need to be communicated to AAT2870 through I²C:

- Write AAT2870 7-bit I²C address: 0x60 (binary 110000; first byte writes as C0h)
- Write to register EN_CHn (00h) data FFh
- Write to register ALS_CFG0 (0Eh) data 61h
- Write to register ALS_CFG1 (0Fh) data 01h
- Write to register ALS_CFG2 (10h) data 0Dh
- Read register ALS_CFG2 (11h); bits AMB[3:0] indicate the ambient light brightness level; first byte writes C1h; all readings are listed in Table 15.
- Write to register ALS0 (12h) data 16h
- Write to register ALS1 (13h) data 1Bh
- Write to register ALS2 (14h) data 1Fh
- Write to register ALS3 (15h) data 24h
- Write to register ALS4 (16h) data 28h
- Write to register ALS5 (17h) data 2Ch
- Write to register ALS6 (18h) data 31h
- Write to register ALS7 (19h) data 35h
- Write to register ALS8 (1Ah) data 3Ah
- Write to register ALS9 (1Bh) data 3Eh
- Write to register ALSA (1Ch) data 43h
- Write to register ALSB (1Dh) data 47h
- Write to register ALSC (1Eh) data 4Ch
- Write to register ALSD (1Fh) data 50h
- Write to register ALSE (20h) data 54h
- Write to register ALSF (21h) data 59h

ALS Read Data Register AMB (11h) (LOG Output)	Light Brightness (Lux)	Log of Brightness/Floor Level	LED Current (mA)	AMB_IN Voltage (mV)	Register Address (Hex)	Register Data (Dec)	Register Data (Hex)	Register Data (Binary)
0	40	0	5.0	78.00	12h	22	16h	0010110
1	50	0.09	6.0	96.67	13h	27	1Bh	0011011
2	61	0.19	7.0	119.81	14h	31	1Fh	0011111
3	76	0.28	8.0	148.49	15h	36	24h	0100100
4	94	0.37	9.0	184.03	16h	40	28h	0101000
5	117	0.47	10.0	228.07	17h	44	2Ch	0101100
6	145	0.56	11.0	282.66	18h	49	31h	0110001
7	180	0.65	12.0	350.32	19h	53	35h	0110101
8	223	0.75	13.0	434.17	1Ah	58	3Ah	0111010
9	276	0.84	14.0	538.09	1Bh	62	3Eh	0111110
10	342	0.93	15.0	666.89	1Ch	67	43h	1000011
11	424	1.03	16.0	826.51	1Dh	71	47h	1000111
12	525	1.12	17.0	1024.35	1Eh	76	4Ch	1001100
13	651	1.21	18.0	1269.53	1Fh	80	50h	1010000
14	807	1.30	19.0	1573.40	20h	84	54h	1010100
15	1000	1.40	20.0	1950.00	21h	89	59h	1011001

Table 15: Ambient Light Sensor Logarithmic Brightness Readings and Logarithmic Backlight Response.

LED Backlight Driver and Multiple LDO Lighting Management Unit

**Content Adjustable
 Brightness Control (CABC)**

The CABC response to an external PWM signal is set by the filter capacitor C_F connected to the FLTR pin. In order to select the filter cap C_F properly, three conditions need to be known:

1. PWM signal frequency at the BC_M pin
2. The desired rate of change of the backlight current from one level to another
3. The minimum PWM duty cycle

The capacitor (C_F) connected to the FLTR pin has an internal resistor $R_F = 97.5K$ in parallel to ground. The filter capacitor C_F pin is charged with a $20\mu A$ current source that is modulated with the BC_M duty cycle. Refer to Figures 30 and 31 for circuit and timing diagrams. The voltage generated on the FLTR pin (V_{FLTR}) is compared to a linearly ramping $1.95V$ voltage source (V_{RAMP}), which creates an internal $82kHz$ PWM signal (f_{PWM})

The value for C_F can be calculated with the following equation:

$$C_F = \frac{T_F}{\left[R_F \cdot \ln \left(\frac{V_{RAMP}}{1.95V} \right) \right]}$$

If the selected C_F capacitor value is smaller than $5nF$, then the ripple appearing on the backlight PWM current will increase. For external BC_M PWM signals equal or lower than 10% duty cycles, the bottom level of the ripple can cause the internal comparators to trip and as a result, the part will switch for a few clock periods to a maximum duty cycle of 97.5%.

If the selected filter cap C_F value is large, the ripple on the backlight PWM current will be reduced but it may not be possible to achieve a fast change (T_F) of the backlight current level or the desired duty cycle.

If the BC_M pin is brought low after being high, C_F will discharge through the internal $97.5K\Omega$ resistor. As FLTR pin voltage decreases, the internal PWM duty cycle will start dropping as well until it reaches approximately 10%, at which point AAT2870 will be latched into maximum duty cycle mode. Now C_F will be charged, and the duty cycle will increase until it reaches maximum duty cycle. If at anytime BC_M is pulled up, the maximum duty cycle mode latch will be released, and normal PWM operation will resume.

If the CABC function is not desired it can be disabled by changing bit CABC from 0 to 1 in ALS_CFG2 (10h) register. AAT2870 will operate with maximum duty cycle of 97.5% and C_F capacitor is not necessary to be connected to the FLTR pin.

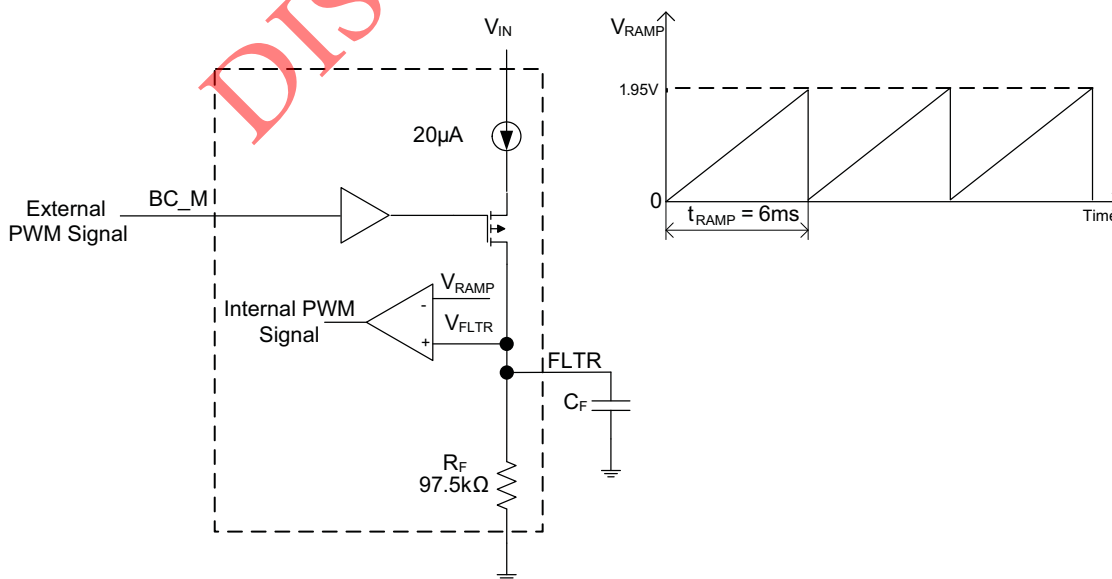

Figure 30: CABC Circuit Diagram.

LED Backlight Driver and Multiple LDO Lighting Management Unit

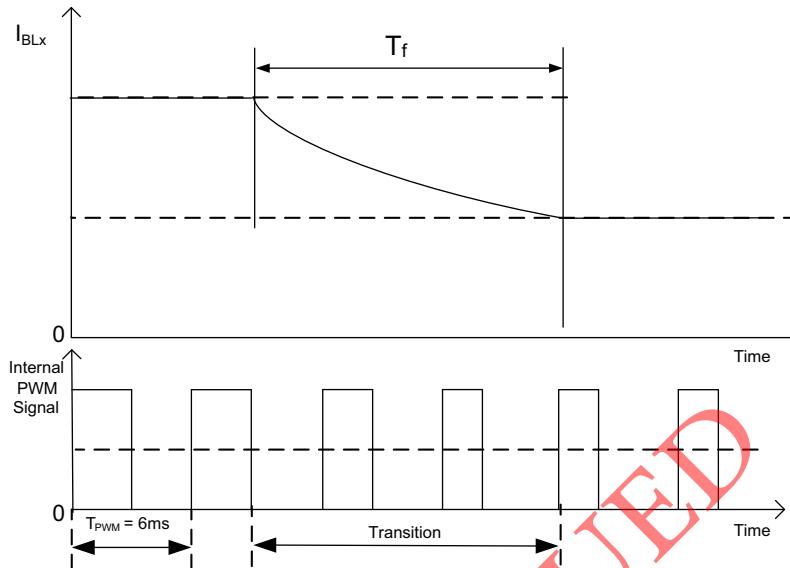

Figure 31: CABC Timing.

A small value C_F will result in faster transition time (T_f) between current levels but is limited to 5nF by the backlight PWM current ripple.

Negative Charge Pump

The AAT2870's charge pump engine produces a negative voltage V_{NEG} from -0.5V to -3V. The backlight current sinks can be referenced to either ground or V_{NEG} depending on the V_F of the white LED diodes. The charge pump output capacitor C_{NEG} is connected between V_{IN} and V_{NEG} .

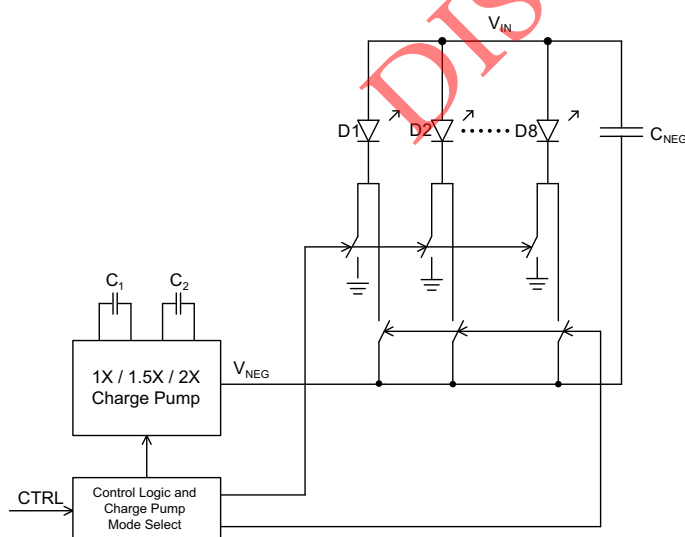

Figure 32: Block Diagram of Negative Charge Pump.

LED Selection

The AAT2870 is specifically intended for driving white LEDs in TFT-LCD backlighting applications. However, the device design will allow the AAT2870 to drive most types of LEDs with forward voltage specifications ranging from 2.0V to 4.7V. LED applications may include mixed arrangements for display backlighting, color (RGB) LEDs, infrared (IR) diodes or any other load needing a constant current source generated from a varying input voltage. Since the BL1 to BL8 constant current sinks are matched with negligible voltage dependence, the constant current channels will be matched regardless of the specific LED forward voltage (V_F) levels.

The low-dropout current sinks in the AAT2870 maximize performance and make it capable of driving LEDs with high forward voltages.

Device Switching Noise Performance

The AAT2870 operates at a fixed frequency of 1.3MHz to control noise and limit harmonics that can interfere with the RF operation of cellular telephone handsets or other communication devices. Back-injected noise appearing on the input pin of the charge pump is typically lower than inductor-based DC/DC boost converter white LED

LED Backlight Driver and Multiple LDO Lighting Management Unit

backlight solutions. The AAT2870 soft-start feature prevents noise transient effects associated with in-rush currents during the start up of the charge pump circuit.

Power Efficiency and Device Evaluation

Charge-pump efficiency discussion in the following section accounts only for the efficiency of the charge pump itself. Due to the unique circuit architecture and design of the AAT2870, it is very difficult to measure efficiency in terms of a percent value comparing input power over output power due to varying conditions created by external LED forward voltage levels at any given drive current.

Since the AAT2870 outputs are pure constant current sinks and typically drive individual loads, it is difficult to measure the output voltage for a given output (BL1 to BL8) to derive an overall output power measurement. For any given application, white LED forward voltage levels can differ, yet the output drive current will be maintained as a constant.

This makes quantifying output power a difficult task when taken in the context of comparing to other white LED driver circuit topologies. A better way to quantify total device efficiency is to observe the total input power to the device for a given LED current drive level. The *best* White LED driver for a given application should be based on trade-offs of size, external component count, reliability, operating range and total energy usage...*Not just "% efficiency"*.

The AAT2870 efficiency may be quantified under very specific conditions and is dependent upon the input voltage versus the output voltage seen across the loads applied through current sinks BL1 to BL8 for a given constant current setting. Depending on the combination of V_{IN} and voltages sensed at the current sinks, the device will operate in 1X mode. When any one of the voltages sensed at the current sinks nears dropout, the device will operate in 1.5x or 2x charge pump mode. Each of these modes will yield different efficiency values. One should refer to the following two sections for explanations for each operational mode.

Charge Pump Capacitor Selection

Careful selection of the four external capacitors C_{IN} , C_1 , C_2 , C_{NEG} is important because they will affect turn on time, output ripple and transient performance. Optimum

performance will be obtained when low ESR (<100m Ω) ceramic capacitors are used. In general, low ESR may be defined as less than 100m Ω . A capacitor value of 0.22 μ F¹ for C_1 and C_2 capacitors is recommended. C_{IN} and C_{NEG} are recommended to be 2.2 μ F or higher. If the constant current sinks are only programmed for light current levels, then the capacitor size may be decreased.

Capacitor Characteristics

Ceramic composition capacitors are highly recommended over all other types of capacitors for use with the AAT2870. Ceramic capacitors offer many advantages over their tantalum and aluminum electrolytic counterparts. A ceramic capacitor typically has very low ESR, is lowest cost, has a smaller PCB footprint and is non-polarized. Low ESR ceramic capacitors help maximize charge pump transient response. Since ceramic capacitors are non-polarized, they are not prone to incorrect connection damage.

Equivalent Series Resistance (ESR)

ESR is an important characteristic to consider when selecting a capacitor. ESR is a resistance internal to a capacitor, which is caused by the leads, internal connections, size or area, material composition and ambient temperature. Capacitor ESR is typically measured in milliohms for ceramic capacitors and can range to more than several ohms for tantalum or aluminum electrolytic capacitors.

Ceramic Capacitor Materials

Ceramic capacitors less than 0.1 μ F are typically made from NPO or COG materials. NPO and COG materials typically have tight tolerance and are stable over temperature. Larger capacitor values are typically composed of X7R, X5R, Z5U or Y5V dielectric materials. Large ceramic capacitors, typically greater than 2.2 μ F are often available in low cost X7R and X5R dielectrics.

Capacitor area is another contributor to ESR. Capacitors that are physically large will have a lower ESR when compared to an equivalent material smaller capacitor. These larger devices can improve circuit transient response when compared to an equal value capacitor in a smaller package size.

1. Or alternate value of 1 μ F.

LED Backlight Driver and Multiple LDO Lighting Management Unit

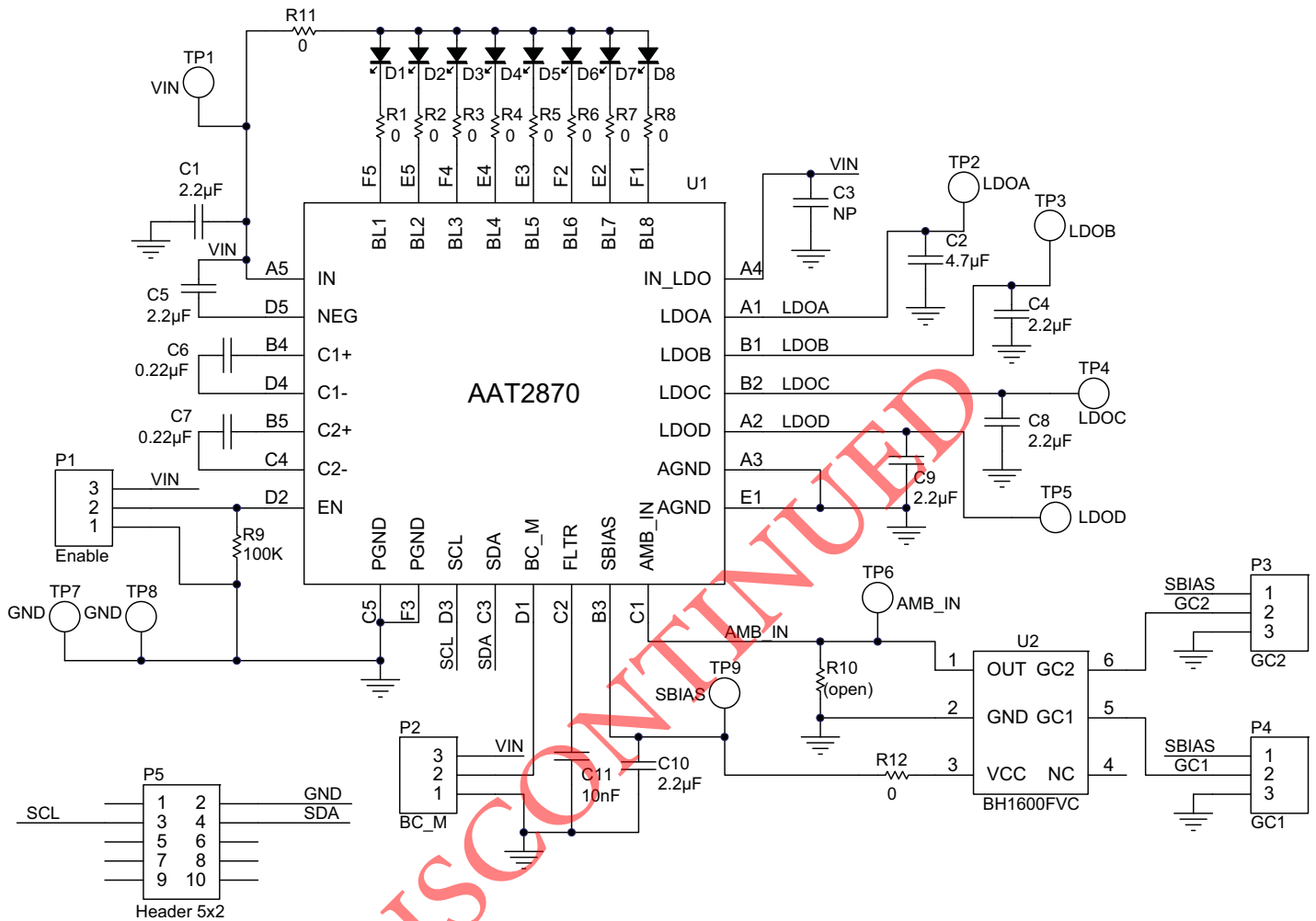

Figure 33: AAT2870 Evaluation Board Schematic.

LED Backlight Driver and Multiple LDO Lighting Management Unit

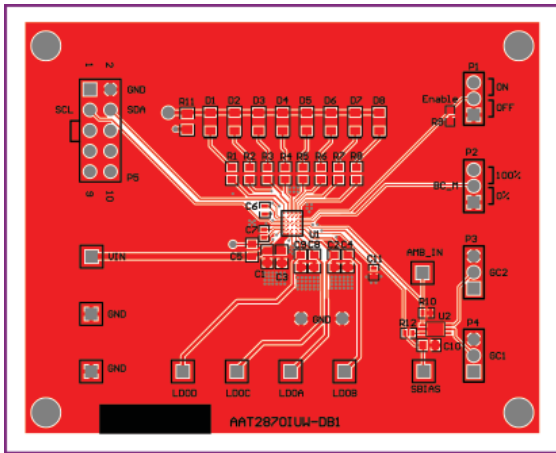

Figure 34: AAT2870 Evaluation Board Top Side Layout.

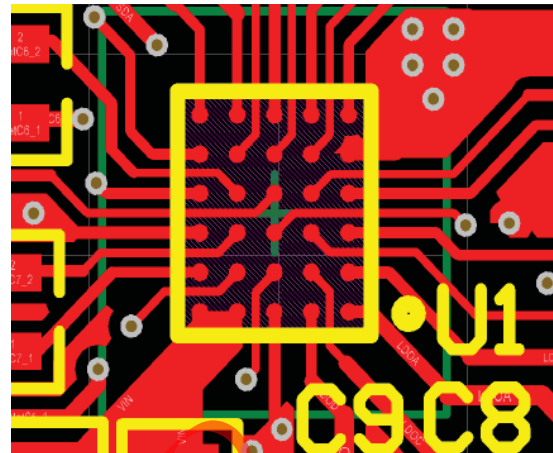

Figure 35: AAT2870 Evaluation Board Top Side Layout (Detail).

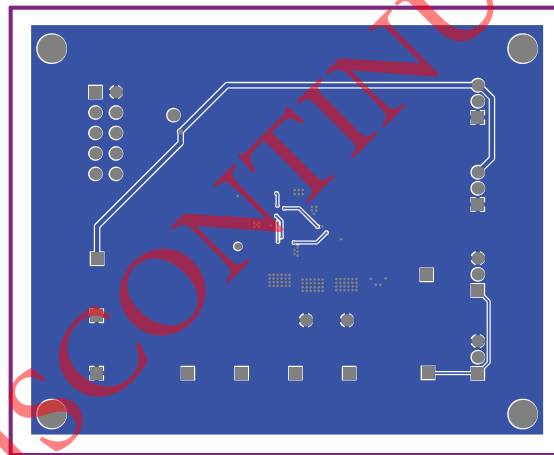

Figure 36: AAT2870 Evaluation Board Bottom Side Layout.

Component	Part Number	Description	Manufacturer
U1	AAT2870IUW-T1	Backlight and LDO Lighting Management Unit	Skyworks
U2	BH1600FVC	Ambient Light Sensor	Rohm
C1, C3, C4, C5, C8-C10	GRM188R60J225KE01B	2.2μF, 6.3V, 10%, X5R; 0603	Murata
C2	GRM188R60J475ME19B	4.7μF, 6.3V, 10%, X5R; 0603	
C6, C7	GRM188R71A224KA01D	0.22μF, 10V, 10%, X7R; 0603	
C11	GRM033R71A103KA01D	10nF, 10V, 10%, X7R; 0402	
R1-R8, R11	Chip Resistor	0Ω, 1%, 1/4W; 0603	Vishay
R9	Chip Resistor	100kΩ, 1%, 1/4W; 0603	
P1, P2, P3, P4	NRPN361PAEN	2mm Header, 3 pins	Sullins Electronics
P5		0.1" Header, 2x5 pins	
D1-D8	LW M673	White LED Diode	OSRAM

Table 16: AAT2870 Evaluation Board Bill of Materials (BOM).

LED Backlight Driver and Multiple LDO Lighting Management Unit

Ordering Information

Package	Marking ¹	Part Number (Tape and Reel) ²
WLCSP-30	G4YY	AAT2870IUW-T1

 Skyworks Green™ products are compliant with all applicable legislation and are halogen-free. For additional information, refer to *Skyworks Definition of Green™*, document number SQ04-0074.

Package Information

**3.1mm x 2.6mm WLCSP-30
(5 x 6 ball array)**

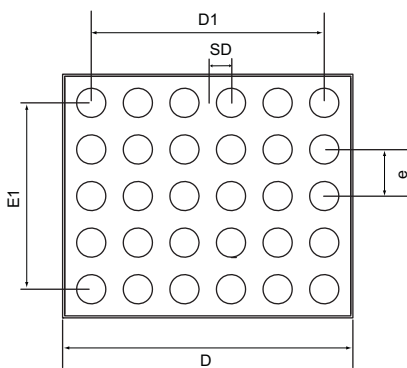

Bottom View

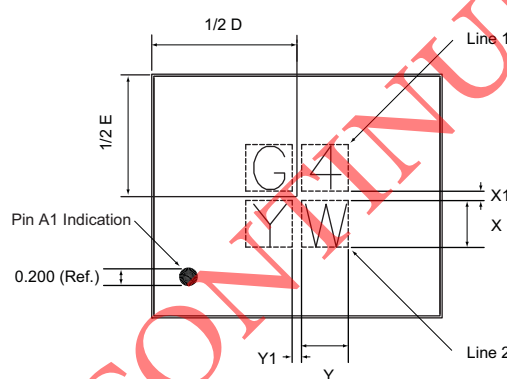

Top View

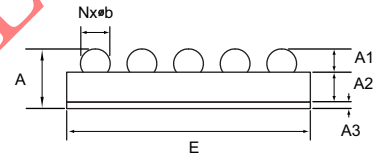

Side View

Symbol	Min	Nom	Max
A	0.610	0.695	0.780
A1	0.220	0.245	0.270
A2	0.355	0.380	0.405
A3	0.035	0.070	0.105
D	3.080	3.115	3.150
E	2.580	2.615	2.650
D1		2.500 BSC	
E1		2.000 BSC	
SE		n/a	
SD		0.250 BSC	
b	0.285	0.310	0.335
e		0.500 BSC	
X	0.600		
X1		0.200	
Y	0.600		
Y1		0.200	
N		30 (balls)	

All dimensions in millimeters.

1. YY = date code.
2. Sample stock is typically held on part numbers listed in **BOLD**.

LED Backlight Driver and Multiple LDO Lighting Management Unit

DISCONTINUED

Copyright © 2012 Skyworks Solutions, Inc. All Rights Reserved.

Information in this document is provided in connection with Skyworks Solutions, Inc. ("Skyworks") products or services. These materials, including the information contained herein, are provided by Skyworks as a service to its customers and may be used for informational purposes only by the customer. Skyworks assumes no responsibility for errors or omissions in these materials or the information contained herein. Skyworks may change its documentation, products, services, specifications or product descriptions at any time, without notice. Skyworks makes no commitment to update the materials or information and shall have no responsibility whatsoever for conflicts, incompatibilities, or other difficulties arising from any future changes.

No license, whether express, implied, by estoppel or otherwise, is granted to any intellectual property rights by this document. Skyworks assumes no liability for any materials, products or information provided hereunder, including the sale, distribution, reproduction or use of Skyworks products, information or materials, except as may be provided in Skyworks Terms and Conditions of Sale.

THE MATERIALS, PRODUCTS AND INFORMATION ARE PROVIDED "AS IS" WITHOUT WARRANTY OF ANY KIND, WHETHER EXPRESS, IMPLIED, STATUTORY, OR OTHERWISE, INCLUDING FITNESS FOR A PARTICULAR PURPOSE OR USE, MERCHANTABILITY, PERFORMANCE, QUALITY OR NON-INFRINGEMENT OF ANY INTELLECTUAL PROPERTY RIGHT; ALL SUCH WARRANTIES ARE HEREBY EXPRESSLY DISCLAIMED. SKYWORKS DOES NOT WARRANT THE ACCURACY OR COMPLETENESS OF THE INFORMATION, TEXT, GRAPHICS OR OTHER ITEMS CONTAINED WITHIN THESE MATERIALS. SKYWORKS SHALL NOT BE LIABLE FOR ANY DAMAGES, INCLUDING BUT NOT LIMITED TO ANY SPECIAL, INDIRECT, INCIDENTAL, STATUTORY, OR CONSEQUENTIAL DAMAGES, INCLUDING WITHOUT LIMITATION, LOST REVENUES OR LOST PROFITS THAT MAY RESULT FROM THE USE OF THE MATERIALS OR INFORMATION, WHETHER OR NOT THE RECIPIENT OF MATERIALS HAS BEEN ADVISED OF THE POSSIBILITY OF SUCH DAMAGE.

Skyworks products are not intended for use in medical, lifesaving or life-sustaining applications, or other equipment in which the failure of the Skyworks products could lead to personal injury, death, physical or environmental damage. Skyworks customers using or selling Skyworks products for use in such applications do so at their own risk and agree to fully indemnify Skyworks for any damages resulting from such improper use or sale.

Customers are responsible for their products and applications using Skyworks products, which may deviate from published specifications as a result of design defects, errors, or operation of products outside of published parameters or design specifications. Customers should include design and operating safeguards to minimize these and other risks. Skyworks assumes no liability for applications assistance, customer product design, or damage to any equipment resulting from the use of Skyworks products outside of stated published specifications or parameters.

Skyworks, the Skyworks symbol, and "Breakthrough Simplicity" are trademarks or registered trademarks of Skyworks Solutions, Inc., in the United States and other countries. Third-party brands and names are for identification purposes only, and are the property of their respective owners. Additional information, including relevant terms and conditions, posted at www.skyworksinc.com, are incorporated by reference.